

*e-medic*TM

DISPLAY SYSTEMS

19AM | 19AM Touch
22AM | 22AM Touch
24AM | 24AM Touch



MANUAL

© 2018 Baaske Medical GmbH & Co.KG. All rights reserved.

Information in this document has been carefully checked for accuracy; however, no guarantee is given to the correctness of the contents. Photographs and schematic diagrams used in this document are for illustration purposes only. The actual product may vary. This document contains proprietary information protected by copyright. No part of this manual may be reproduced by any mechanical, electronic, or other means, in any form, without prior written permission of Baaske Medical.

This document is subject to change without notice.

E-MEDIC™ DISPLAYS AM

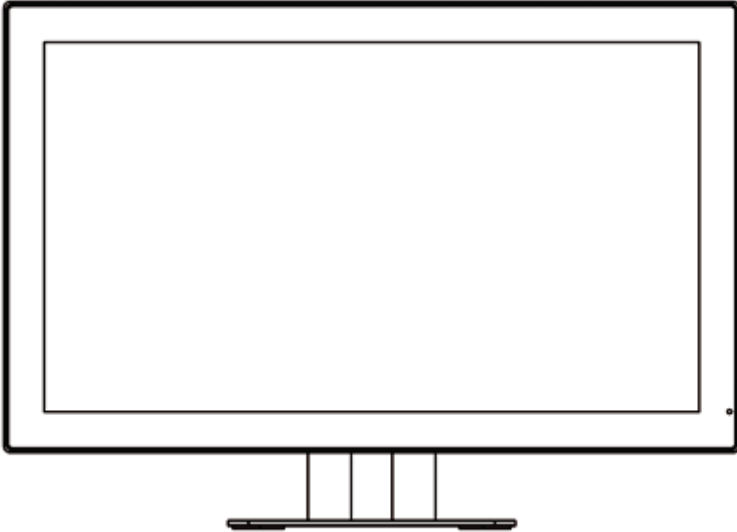

Conformity according to the Council Directive 93/42/EEC concerning Medical Device.



Use this product after carefully reading this Manual and understanding the contents. Store this manual with care, as close as possible, so that you can read whenever necessary.

E-MEDIC™ DISPLAYS AM

Thank you for purchasing our color LCD Display.

- Carefully read this User's Manual and use the product properly. Before using it, also read „Safety Precautions.“
- Keep the User's Manual as close to you as possible and in safe custody.
- If you have lost the manual, contact your dealer. We will reissue a manual.
- The names of companies and products are registered brand names or brand names.

Revision History

The revision letter changes with related comments each time the document is updated.

Revision	Comment
A	A Initial release of this document
B	Update 3.1

TABLE OF CONTENTS

Revision history	4
Safety precautions	6
Equipment symbols	9
Cleaning instructions	11
Disposal of the unit	11
Auxiliaries	12
Application and function description	13
Features	14
Connection method	15
How to operate	19
Charts of OSD adjustment functions	20
Reference	31
Contact informations	31

SAFETY PRECAUTIONS

I Classification



MEDICAL-GENERAL MEDICAL EQUIPMENT AS TO ELECTRICAL SHOCK, FIRE AND MECHANICAL HAZARDS ONLY IN ACCORDANCE WITH ANSI/AAMI ES60601-1(2005)+A1(2012) AND CAN/CSA-C22.2 NO. 60601-1(2014)

Class I: No applied parts

Protection against harmful ingress of water is IPX0

Not suitable for use in the presence of flammable anesthetic's or oxygen.

Mode of operation: Continuous.

II External Equipment

External equipment intended for connection to signal input / output or other connectors, shall comply with UL/EN 60601-1 for medical electrical equipment. In addition, all such combination system shall comply with the standard IEC 60601-1-1, Safety requirements for medical electrical systems. Equipment not complying with UL/EN/IEC 60601-1 shall be kept outside the patient environment, as defined on the systems standard.

III Intended Use

This device displays video images from medical equipment. It is intended to be used as a reference display. It's not for diagnostic consultation. This device can operate repetitively.

Part of the body or type of tissue applied to or interacted with:

Part of the body contacted with the device is finger, palm, and hand.

Intended User Profile	
Age:	Adult (Age above 21)
Gender:	Can be use by all genders
Linguistic/ Cultural Background:	At least English
Education/ Professional Competence:	General level of education
Intended User Group:	Hospital staff
Knowledge Base:	User should possess basic medical knowledge

V FCC

FCC Information

FCC (U. S. Federal Communications Commission)

This equipment has been tested and found to comply with the limits for a Class B digital device, pursuant to part 15 of the FCC Rules. These limits are designed to provide reasonable protection against harmful interference in a residential installation. This equipment generates, uses, and can radiate radio frequency energy, and if not installed and used in accordance with the instructions, may cause harmful interference to radio communications. However, there is no guarantee that interference will not occur in a particular installation. If this equipment does cause unacceptable interference to radio or television reception, which can be determined by turning the equipment off and on, the user is encouraged to try to correct the interference by one or more of the following measures:

- Reorient or relocate the receiving antenna.
- Increase the separation between the equipment and receiver.
- Connect the equipment into an outlet on a circuit different from that to which the receiver is connected.
- Consult your dealer or an experienced radio/TV technician for help.

FCC Warning:

To assure continued FCC compliance, the user must use a grounded power supply cord and the provided shielded video interface cable with bonded ferrite cores. Also, any unauthorized changes or modifications to this monitor would void the user's authority to operate this device.

VI Precautions

- Make sure to carefully read the Operating Manual prior to using the monitor in order to properly use the monitor.
- Note that, excluding those cases where a responsibility for legal compensation is recognized, the manufacturer shall bear absolutely no responsibility for damage to this product by a customer or a third party that results from the ignoring of contents entered in this Operating Manual and mistaken use.

-
- Follow the instructions below for safety use of the LCD Monitor.
 - To avoid electric shock, do not attempt to remove any cover or touch the inside of the monitor. Only a qualified service technician should open the monitor case.
 - Do not insert metal objects or spill liquid into the LCD monitor through cabinet slots. They may cause accident fire, electric shock or failure. If a foreign object inserted or water penetrated, unplug the AC cable and have the monitor serviced.
 - Do not cover or block the vent holes in the case.
 - Disconnect the power plug from the AC outlet if you will not use it for an indefinite period of time.
 - Do not apply pressure to the screen. The LCD is very delicate.
 - If your LCD monitor uses an AC/DC Adapter: Only use the Adapter, which accompanied with this device. Use of another AC/DC Adapter may cause a malfunction or danger.
 - If your LCD monitor does not operate normally-in particular, if there are any unusual sounds or smells coming from it-unplug the AC cable immediately and contact the manufacturer, authorized or service center.
 - No modification of this equipment is allowed.
 - OPERATOR not to touch enclosure and PATIENT simultaneously.
 - No connect to multiple socket outlets.
 - To avoid the risk of electric shock this equipment must only be connected to a supply mains with protective earth.

VII Environment

- Place the monitor on a flat and leveled surface.
- Place the monitor in a well-ventilated place.
- Keep the monitor away from: overly hot, cold or humid places, places directly under sunlight, dusty surroundings, equipment that generate strong magnetic fields.

EQUIPMENT SYMBOLS

Electrical and Electronic Equipment Symbols

In addition to the equipment symbols described in your user's manual, the following symbols may be appear on the monitor.

-  Alternating current.
-  Direct current.
-  European Union Declaration of Conformity.
-  FCC. USA only. Complies with applicable US government (Federal Communications Commission) radio-frequency interference regulations.
-  Fragile. Handle with care.
-  Indicates front.
-  Keep dry. Protect from rain.
-  ON. Power connection to the mains.
-  Recycled materials or may be recycled.
-  Stacking limit by number.
-  Standby or power indicator.
-  This way up.

EQUIPMENT SYMBOLS



USB connector port.



Power OFF.



This symbol indicates that the waste of electrical and electronic equipment must not be disposed as unsorted municipal waste and must be collected separately. Please contact an authorized representative of the manufacturer for information concerning the decommissioning of your equipment.



ATTENTION: Consult accompanying documents.



DANGER - Shock Hazard. Dangerous voltage. To reduce the risk of electric shock, do not remove cover. Refer servicing to qualified service personnel.



ATTENTION: Consult accompanying documents.



Equipotentiality. Connect device to a potential equalization conductor.

CLEANING INSTRUCTIONS

Cleaning the Cabinet and the LCD Display

- When cleaning, remove the outlet from the LCD display for safety.
- Lightly wipe off dirt on the cabinet and LCD panel surface with a hard-wrung soft cloth soaked in a neutral cleaning solution. Follow its instruction when using a disposable cloth.
- Do not use thinner, benzine, alcohol or such on the cabinet that is made of plastic. These can damage the cabinet, alter its quality and cause the paint to peel off.
- Do not apply insecticides and other volatile items to the cabinet. Also do not leave rubber and vinyl products or such in contact with it for long hours. This can cause the quality to alter and the paint to peel off.
- Cleaners usable for the LCD panel are isopropyl alcohol(without abrasive), non-ammonic glass cleaner, and watered-down neutral cleaning solution. Do not use organic solvent such as acetone and toluene.
- When the screen has dust on the LCD panel surface, wipe it off with soft moist cloth.
- Treat the LCD panel wit care. Do not rub the LCD panel surface with a rough item or hit it on the surface. Also, do not strongly press the LCD panel surface. This can lead to unevenness in the screen and also to failure of the product.

DISPOSAL OF THE UNIT

- **Do not dispose of this product with general wastes.**
- **Follow your local regulations or rules upon dispose of this product.**
- **Hg Warning**

This product consists of devices that may contain mercury, which must be recycled or disposed of in accordance with local, state, or country laws. (Within this product, the backlight lamps in the display contain mercury.)

AUXILIARIES

Check List

Before operating this monitor, please make sure that all items listed below are present in your package:

e-medic™ Display AM

- The LCD monitor
- User's manual
- AC Power cord
- VGA Cable
- DP Cable
- DVI Cable

Optional Items

These are optional items and can be ordered by contacting dealer directly.

- VESA® standard wall/arm mount kits
- *1 USB / RS232 Cable

If any of the above items are found missing or if you wish to order the optional items, please contact your dealer.

***1 For the Touch unit with the USB / RS232 input connector**

NOTES
<ul style="list-style-type: none">* We recommend you to keep the packing box for transportation and the like.* In case of transporting and packing the unit in the packing box, carefully place it, keeping its panel from touching any objects.

APPLICATION AND FUNCTION DESCRIPTION

Some Basic Facts

The medical safety approved e-medic models are versatile monitors designed for ergonomic and easy handling. The liquid-crystal display (LCD) monitors supports the most common resolutions and presents sharp, low-radiation images.

With the OSD wheel knob on the bottom right side of the displays leaves ample space on your desk for other peripheral equipment.

An VESA 100 adapter according to VESA standard is available on the rear cover for wall or swivel-arm mounting.

Function Description

The medical flat-screen displays are built into a slim and ergonomic housing.

The e-medic models are optional equipped with a protection glass or IPX1 protection against water drops.

The signal is equivalent to the analog and digital standard signals of your PC.

After connection of the signal the flat-screen display automatically adapts, as far as possible, to the VGA signal and presents a stable and centered image. Additional display parameters, such as brightness and contrast, can be adjusted via the on-screen menu. The equipment come with the signal cables, the medical-grade power supply with power cord and this user manual.

FEATURES

- **LCD Display**

- **19-inch LCD display**

This color LCD display has a multi-scanning function corresponding to the resolution from VGA 640x480 to WXGA 1366x768. This is also compliant with VESA standard display mode.

- **22-inch LCD display**

This color LCD display has a multi-scanning function corresponding to the resolution from VGA 640x480 to FHD 1920x1080. This is also compliant with VESA standard display mode.

- **24-inch LCD display**

This color LCD display has a multi-scanning function corresponding to the resolution from VGA 640x480 to FHD 1920x1080. This is also compliant with VESA standard display mode.

- **Power management**

This unit has loaded the power management system. The power management mode functions when either horizontal or vertical signals or both disappears. And it reduces power consumption to less than 5W.

- **VESA® standart wall / arm mountings**

The unit is compliant with VESA mount hanging tools. The tilt stand is detachable; the unit can be set for wall-hanging or arm according to users' environment.

- **Security device slot for Kensington® security system**

Anti-theft security device slot has been loaded to correspond to MicroSave® security system of Kensington®.

CONNECTION METHOD

No tools are required to set up the LCD monitor. Simply follow the instructions outlined in the next few pages.

Connectors for the signal cables, power are located on the back of the panel behind the cover door. Please refer to the diagram on this page for the connector configuration.

Connect Power Adapter and Cable

Connect the female end of the power cable to the AC power input receptacle on the LCD Monitor. Then, plug the male end of the power cable into an AC outlet.

Connect DVI/DP Cable

If you have a DVI/DP digital graphics card adapter and a DVI/DP cable, connect it to the DVI/DP connector of the monitor. The optional DVI/DP graphics adapter and the DVI/DP cable can be ordered by contacting dealer directly.

VGA connector

The VGA cable is transmitting the image data to your flat screen. The cable has two 15pin D-Sub VGA connectors to connect to your graphic adapter.

- Connect one end of the cable with your flat screen. Take care to connect it correctly and please use the little screws to make sure the cable will not disconnect.
- Connect the other end of the VGA cable with the graphics adapter in your computer.

Please use the little screws to make sure the cable will not disconnect.

- First turn on your flat screen and then turn on your computer.

The LED is green until the display receives a signal from the computer.

***Connect USB / RS232 Cable**

Connect USB / RS232 in connector of the LCD monitor and PC out device.

With the attached USB / RS232 cable.

***Connect Audio Cable**

Connect Audio in connector of the LCD monitor and Audio out device (PC.DVD,CD...) with the attached stereo mini cable.

Anti-Theft Security Lock Slot

The LCD monitor is equipped with a security lock slot compatible to Kensington® security lock type. The security cable lock maybe available thru your dealer or it can be purchased at most computer peripheral stores near you.

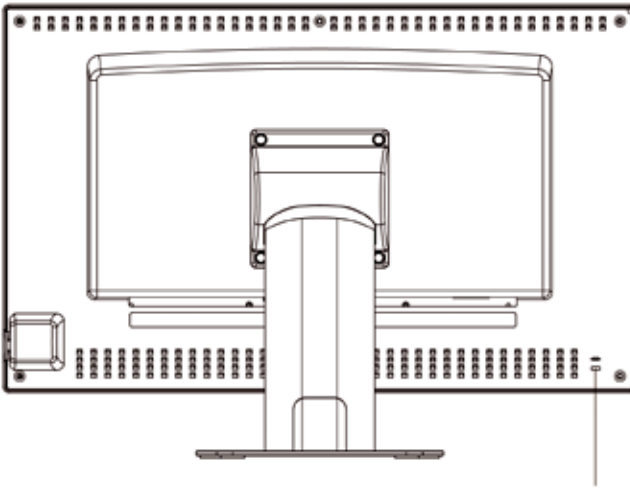

Security Lock Slot

Wall/arm VESA mounting the Monitor If you intend to mount the monitor on the wall/arm, we strongly recommend that you use only UL approved wall/arm mount kits with attached M4*10mm screws and can load more than monitor weight, that you ensure it is securely and safely installed. (VESA mounting for 100*100mm).

If you use a non-UL approved wall/arm mount kits, there is a safety risk that the Monitor may fall from the wall/arm due to an improper attachment through the use wrong or length screws.

Mounting

The Monitor can be mounted onto the wall or stand.

If you intend to mount the monitor on the wall, we strongly recommend that you use wall mount kits with attached M4*12mm screws and can load more than monitor weight, that you ensure it has been securely and safely installed.

Caution

When mounting the monitor, take care to tighten the retention screws or bolts until fully secure, but do not over tighten. Over tightening the retention screws or bolts may cause them to become stripped, rendering them useless.

Wall Mounting Installation

The Monitor has Video Electronics Standards Association (VESA) standard mounting holestapped into the rear panel. The standard holes are M4*4.

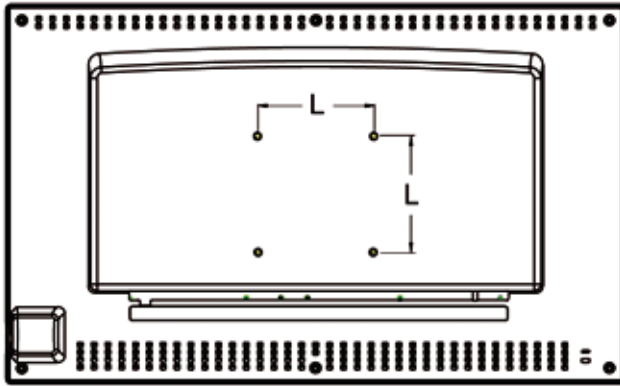

To mount the Monitor onto the wall or stand, please follow the steps below.

- Step 1:** Select the location on the wall for the wall-mounting bracket. (Listed VESA)
- Step 2:** Carefully mark the locations of the four screw holes in the bracket on the wall.
- Step 3:** Drill four pilot holes at the marked locations on the wall for the bracket retention screws.
- Step 4:** Align the wall-mounting bracket screw holes with the pilot holes.
- Step 5:** Secure the mounting-bracket to the wall by inserting the retention screws into the four pilot holes and tightening them.
- Step 6:** Insert the four monitor mounting screws provided in the wall mounting kit into the four screw holes on the rear panel of the LCD Monitor and tighten until the screw shank is secured against the rear panel.
- Step 7:** Align the mounting screws on the monitor rear panel with the mounting holes on the bracket.
- Step 8:** Carefully insert the screws through the holes and gently pull the monitor downwards until the monitor rests securely in the slotted holes. Ensure that all four of the mounting screws fit snugly into their respective slotted holes.
- Step 9:** Secure the LCD Monitor by fastening the retention screw of the wall-mounting bracket.
- Step 10:** Secure the LCD Monitor by fastening the retention screw of the wall-mounting bracket.

HOW TO OPERATE

Names and Functions of Each Part

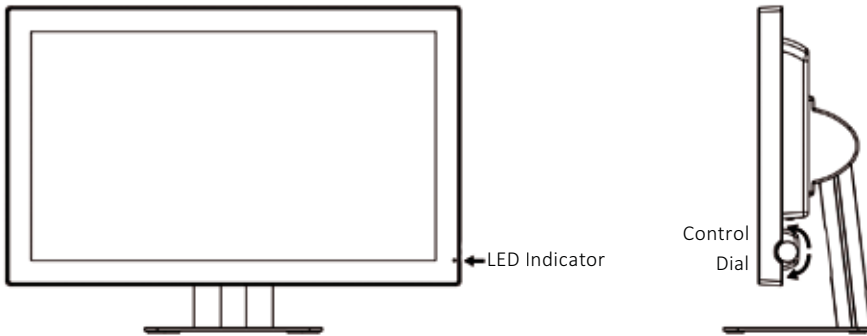

Control Dial

The Control Dial is a multi-functional device located behind the LED Indicator on the right side of the front bezel. It has three movements-rotate upward, rotate downward and press inward as a button.

1. Power On/Off

Press the Control Dial to power the unit on from the off stage (the LED is off). To turn the poweroff, press the Control Dial and hold for at least 1 second until the LED turns off.

2. OSD Control

While the monitor is on (green LED and image on the screen), pressing on the Control Dial activates the OSD. While the OSD menu is active, use the three way movements of the Control Dial to adjust the monitor.

Rotate Downward: Move Up/Right, Increase, Larger, More

Rotate Upward: Move Down/Left, Decrease, Smaller, Less

Button Press: Execute, Do, Save

LED Indicator

This LED indicator turns green when the power is switched ON and the power cord is properly attached. It turns amber when the monitor goes into a power saving mode (Active Off). Please refer to the Power Management section of manual for more information.

CHARTS OF OSD ADJUSTMENT FUNCTIONS

The charts displays the function tree and brief explanations of the functions. Color, LCD, and other adjustments have submenus under each tree.

On-Screen Display

The LCD monitor features an On-Screen Display(OSD) menu with easily identifiable icons designed to make adjustment of your monitor display settings a more user-friendly process. When highlighted, the icon illustrates the control function and brief instruction to assist the user in identifying which control needs adjustment.

The OSD menu is activated by pressing the Control Dial inward and you can select and adjust the function of your choice by rotating and clicking the Control Dial. The main menu displays a list of sub menu icons and the current video input mode. Rotate the dial to move the highlights to the control you would like to adjust, then press the Control Dial inward to select that control or to activate that function. Depending on the control you selected, a submenu of the control with a status bar will appear. The status bar indicates in which direction, from the factory preset, your adjustments are being made. Rotate the Control Dial to adjust the control. When you have finished making the adjustments, the setting is saved automatically by activating the control function. If you do not touch the control dial for 30 seconds, the OSD is automatically exited saving your current settings.

Menu Descriptions

The LCD monitor is capable of accepting VGA, DVI, DisplayPort signal inputs and therefore has two different sets of OSD control functions. Because the digital signaling always achieves optimum display quality without much adjustment, it requires much less OSD functions than the analog input mode. The following options are not available in digital input mode: Auto Setup, Display, Clock/Phase, denoted by as trick (*) in the following descriptions. If switched to digital input model, you will encounter a “Not Available” message.



Auto Setup

Automatically adjust the size, position, contrast, and the like of the screen.
Is this image displayed properly?

Yes: Close OSD window.

No: Return to Phase Menu. (Change manually)



Brightness

Selecting this control allows you to make adjustments to the brightness level of the display screen in the scale of 0 to 100.

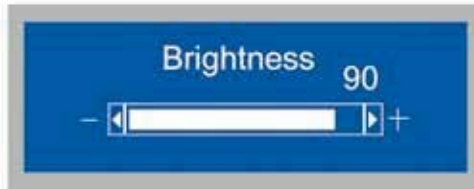

Contrast

Selecting this control allows you to make adjustments to the contrast level of the display screen in the scale of 0 to 100.



Display

Exit

Return to Main Menu.



H. Position

Adjust the horizontal position of the display. When rotating control dial clockwise, the display moves to the right, and vice versa. For the digital input DVI or Display Port, this function is not available.



V. Position

Adjust the vertical position of the display. When rotating control dial clockwise, the display moves to the up, and vice versa. For the digital input DVI or Display Port, this function is not available.



Color Mode

User can make tone adjustments and settings.

Exit

Return to Main Menu.

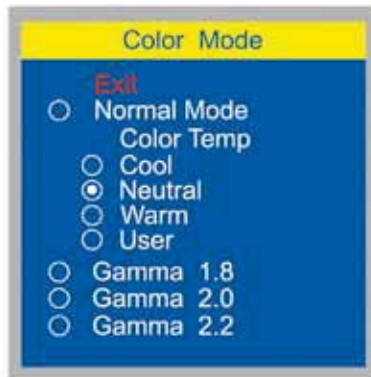

- **Normal:** Selecting this control allows you select color temperature of Cool, Neutral, Warm or User.
- **Cool:** Bluish white for general use and CAD / CAM. 9300K is a fixed value by the manufacturer; User cannot change the setting value.
- **Neutral:** White close to natural light used for publishing trade. 6500K is a fixed value by the manufacturer; User cannot change the setting value.
- **Warm:** Reddish white mainly suited for photo modification. 5400K is a fixed value by the manufacturer; User cannot change the setting value.

-
- **User:** User can adjust and set tones.

Red: Adjust red and equivalent colors at the range from 0 to 100. The greater the value is, the deeper the color is, and vice versa.

Green: Adjust green and equivalent colors at the range from 0 to 100. The greater the value is, the deeper the color is, and vice versa.

Blue: Adjust blue and equivalent colors at the range from 0 to 100. The greater the value is, the deeper the color is, and vice versa.



- **Gamma 1.8**
Gamma 1.8 mode of brightness and gamma property.
- **Gamma 2.0**
Gamma 2.0 mode of brightness and gamma property.
- **Gamma 2.2**
Gamma 2.2 mode of brightness and gamma property.
- **Optional**

NOTE
The intended use of this product is to provide medical image display. The image displayed on this device is for reference purpose only. (GSDF±30 %)

Clock / Phase

Exit

Return to Main Menu.



Clock

When operating „Auto adjustment“ and if any partially phased screen, make fine adjustments on video signal position to horizontally synchronized signals by rotating the control knob. As the value gets larger, the screen moves to the right, and vice versa. The adjustable range is from 0 to 100. For the digital input DVI or Display Port, this function is not available.



Phase

Make „Phase“ adjustments, if any flickers, blurs, or horizontal stripes on screen. Adjustable at the range from 0 to 63. For the digital input DVI or Display Port, this function is not available.



Management



Scaling



OSD Display

Exit

Return to Management Menu.

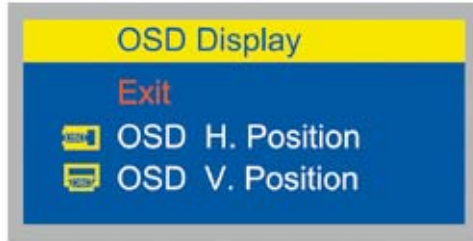

OSD H. Position

Adjust the horizontal position of OSD. When rotating control dial clockwise, OSD moves to the right, and vice versa.



OSD V. Position

Adjust the vertical position of OSD. When rotating control dial clockwise, OSD moves to the up, and vice versa.



Language

Selecting this control to select the language you want.

- **English:** Display OSD in English.
- **Francais:** Display OSD in Francais.
- **Deutsch:** Display OSD in Deutsch.
- **Italiano:** Display OSD in Italiano.
- **Espanol:** Display OSD in Espanol.
- **ニホン:** Display OSD in Japanese.



Source

Selecting this control allows you to manually select VGA or DVI or Display Port to automatically detect input sources all.

- **Exit:** Return to Management Menu.
- **VGA:** Display signal from VGA connector (15-pin Mini D-sub).
In VGA input, it supports Sync-on green and the interlace timing can be displayed.
- **DVI:** Display signal from DVI connector. (24-pin DVI)
- **Displayport:** Display signal from Displayport connector.

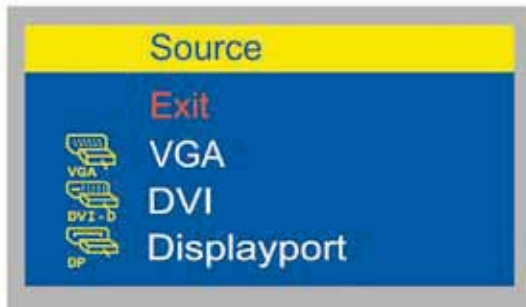

Recall

Initialize the data such as display position and automatic adjustment data to factory default. After initialization, perform „Auto Setup“ again. (VGA only)

Yes: Initial default value to the factory setting.

No: Return to Management menu.



Mute

To control the audio sound of monitor.

On: mute

Off: no mute



Volume

Adjust the volume of the audio sound.

Selecting this control to volume a scaling. At the range from 0 to 100.

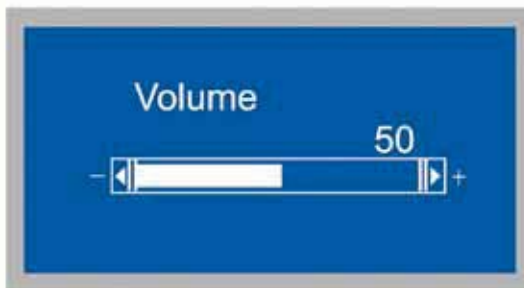

REFERENCE / CONTACT INFORMATION

DDC*¹

This unit has loaded a function compliant with DDC-2B, VESA* standard. The DDC function is located in 15-pin D-sub connector and 24-pin DVI-D connector. This function reads into the set data written in the color LCD display internal device in advance on start-up of Windows®/98/Me/2000 or Windows®XP and sets the detailed information of the color LCD display in the system file in order to achieve Plug & Play. Data reading from the color LCD display is done through a video signal cable, which needs to be connected when Windows®95/98/Me/2000 or Windows®XP is on.

NOTE
<p>*¹DDC (Display Data channel) and*² VESA are registered trademarks of Video Electronics Standards Association.</p>

Manufacturer

Baaske Medical GmbH & Co. KG
Bacmeisterstraße 3, 32312 Lübbecke, Germany
Phone: +49 (0) 5741 236027 -0
Fax: +49 (0) 5741 236027 -99
www.baaske-medical.de

Technical Support

Baaske Medical GmbH & Co. KG
Bacmeisterstraße 3, 32312 Lübbecke, Germany
Phone: +49 (0) 5741 236027 -26
Fax: +49 (0) 5741 236027 -99
www.baaske-medical.de

Consult your dealer for technical support.



Baaske Medical GmbH & Co. KG
Bacmeisterstraße 3
32312 Lübbecke
Tel: +49 5741 236027-0
Fax: +49 5741 236027-99
sales@baaske.net
www.baaske-medical.de