

# Nio Color 5MP

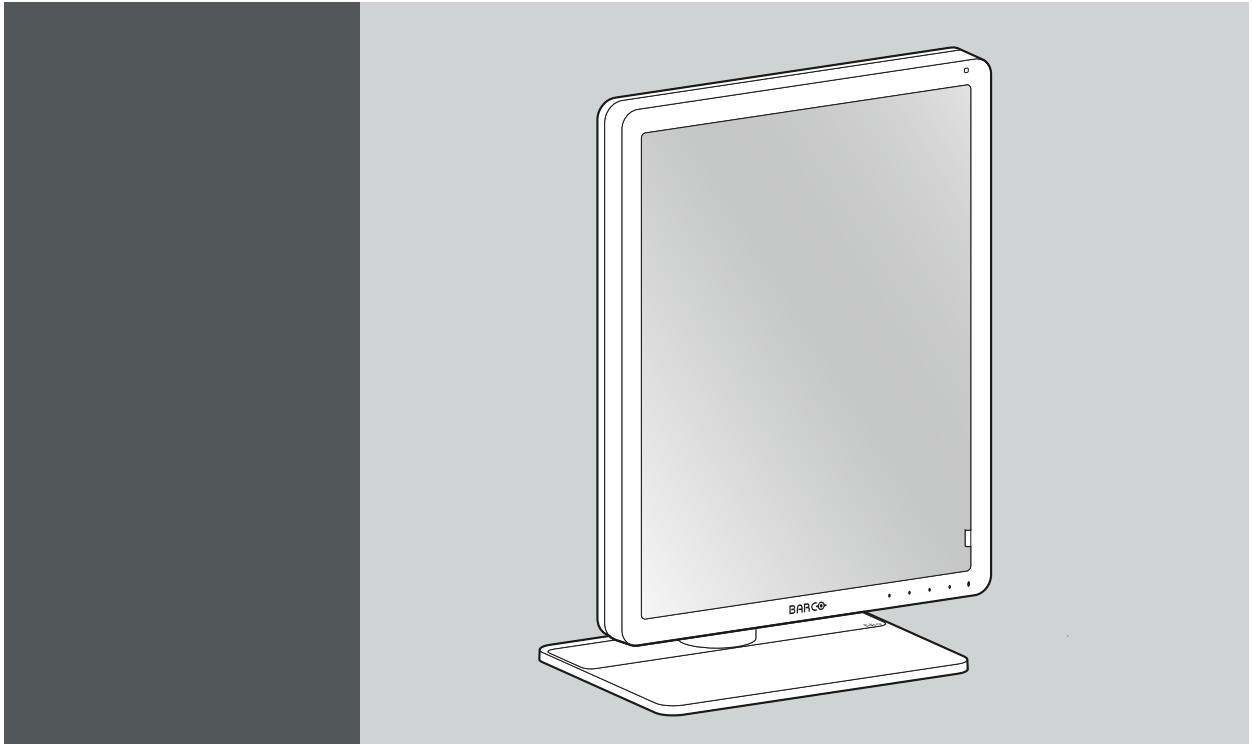

## User Guide 5.8MP high-bright color display

MDNC-6121

**Barco NV**

Beneluxpark 21, 8500 Kortrijk, Belgium

Phone: +32 56.23.32.11

Fax: +32 56.26.22.62

Support: [www.barco.com/en/support](http://www.barco.com/en/support)

Visit us at the web: [www.barco.com](http://www.barco.com)

**Registered address: Barco NV**

President Kennedypark 35, 8500 Kortrijk, Belgium

Phone: +32 56.23.32.11

Fax: +32 56.26.22.62

Support: [www.barco.com/en/support](http://www.barco.com/en/support)

Visit us at the web: [www.barco.com](http://www.barco.com)

---

# TABLE OF CONTENTS

<b>1. Welcome!</b>	<b>3</b>
1.1 What's in the box	3
1.2 Product overview	4
<b>2. Installation</b>	<b>7</b>
2.1 Display position adjustment	7
2.2 Cable connections	8
2.3 VESA-mount installation	10
2.4 First time starting up	12
<b>3. Daily operation</b>	<b>13</b>
3.1 Recommendations for daily operation	13
3.2 Key indicator lights	14
3.3 Standby switching	14
3.4 Bringing up the OSD menus	15
3.5 Navigating through the OSD menus	15
<b>4. Advanced operation</b>	<b>17</b>
4.1 OSD menu language	17
4.2 OSD menu automatic close function	17
4.3 Power LED	17
4.4 Key indicator lights	18
4.5 Power lock function	18
4.6 DPMS mode	18
4.7 Hibernate	19
4.8 Luminance target	19
4.9 Viewing modes	20
4.10 Display functions	20
4.11 Color presets	21
4.12 Ambient Light Compensation (ALC)	22
4.13 Reading rooms	22
4.14 Continuous ALC	23
4.15 Embedded QA	23
4.15.1 About Embedded QA	23
4.15.2 DICOM status report	24
4.15.3 DICOM compliance check	24
4.15.4 DICOM calibration	25
4.15.5 Reset DICOM calibration	25
4.15.6 DICOM error threshold	25
4.16 Display orientation	25
4.17 Image scaling	26
4.18 Image source selection	26
4.19 Grayscale conversion modes	27
4.20 EDID format	28
4.21 EDID timings	28
4.22 Display info	29
4.23 Display status	29
<b>5. Cleaning your display</b>	<b>31</b>
5.1 Cleaning instructions	31
<b>6. Important information</b>	<b>33</b>
6.1 Safety information	33
6.2 Environmental information	35
6.3 Regulatory compliance information	37
6.4 EMC notice	37
6.5 Explanation of symbols	41
6.6 Legal disclaimer	43

*Table of contents*

---

6.7 Technical specifications .....44

# 1. WELCOME!

## Introduction

Thank you for choosing this Nio Color 5MP!

Nio Color 5MP is a 5.8 megapixel highbright display system that is color-calibrated and uniformity corrected, providing excellent image quality for confident diagnoses for medical images including mammography and breast tomosynthesis. With both accurate SteadyColor™ and DICOM-calibrated grays (500 cd/m2 for at least five years) you discern even the tiniest detail even after many years of use.

## The versatile high-resolution color solution on the market

The Nio Color 5MP offers the excellent image quality for gray and color images used in general radiology as well 2D and 3D mammography. Its high brightness and high contrast ratio enable you to unveil even the subtlest details and make accurate diagnoses. The unique 5.8 megapixel format of 2100 columns and 2800 rows shows more pixels on medical images compared to previously available 5MP displays that only have 2560 rows.

With the integrated smart features, you can easily take control and improve your productivity. SpotView™, for example, allows you to focus on an area of interest to unveil even more details. And with DimView™, any auxiliary displays can be automatically dimmed.

The Nio Color 5MP is also an excellent solution for radiologists who want to angle their desktop: it lets you choose your preferred viewing angle and offers a highly ergonomic display configuration. It's also possible to switch between Clear base and Blue base viewing modes on-the-fly. Whether to suit the image type or to change to different reading preferences, you decide which color you want and when.

## Stable image quality, durable investment

Using Barco's integrated front sensor, the Nio Color 5MP works perfectly with Barco's online MediCal QAWeb solution for automated Quality Assurance and calibration. QAWeb guarantees stable DICOM images throughout the display's lifetime.

By default, Barco displays are equipped with an integrated glass cover to safeguard your investment.

Thanks to the highperformance LED backlights, the Nio Color 5MP has a positive impact on both maintenance and operational costs.

## Ultimate peace of mind

Barco is the only company that provides complete system solutions, from display and controllers to workflow tools and calibration via QAWeb. All components are covered by our full 5 year warranty.

At product release, Barco extensively tests the displays compatibility with all major PACS applications.



**WARNING: Please read all important safety information ("Safety information", page 33) prior to installing and operating the Nio Color 5MP. Adhere to all warnings and cautions mentioned in this user guide.**

---

## 1.1 What's in the box

---

### Overview

- MDNC-6121 display
- User guide
- System disc
- Documentation disc
- DisplayPort cable

## 1. Welcome!

---

- Mains cables
- External power supply
- USB cable

If you ordered a Barco display controller, it's also in the box together with its accessories. A dedicated user guide is available on the documentation disc.



**Keep your original packaging. It is designed for this display and is the ideal protection during transport and storage.**

---

## 1.2 Product overview

---

### Front

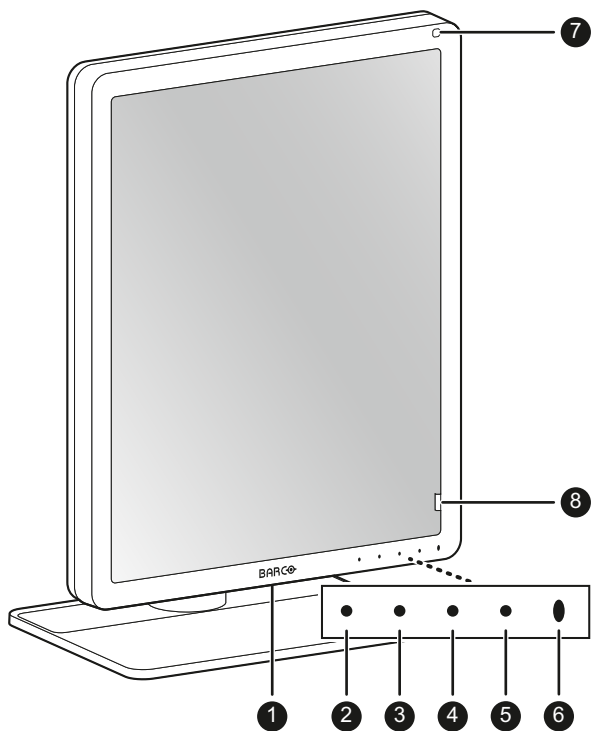

Image 1-1

1. USB-A 2.0 downstream connector
2. Left key
3. Right key
4. Menu key
5. Standby key

6. Power status LED
  - Off: Display not powered, or display operational but power LED function disabled in OSD (see "Power LED", page 17)
  - Steady white: Display operational
  - Slow blinking amber: Display in suspend mode (requires DPMS mode to be enabled in the OSD menu, see "DPMS mode", page 18)
  - Fast blinking amber: Display in standby mode (requires DPMS mode to be enabled in the OSD menu, see "DPMS mode", page 18)
  - Steady amber: Display switched off via the standby key, or display in hibernate mode (requires DPMS mode and Hibernate to be enabled in the OSD menu, see "DPMS mode", page 18 and "Hibernate", page 19)
7. Ambient light sensor
8. Front sensor

## Back

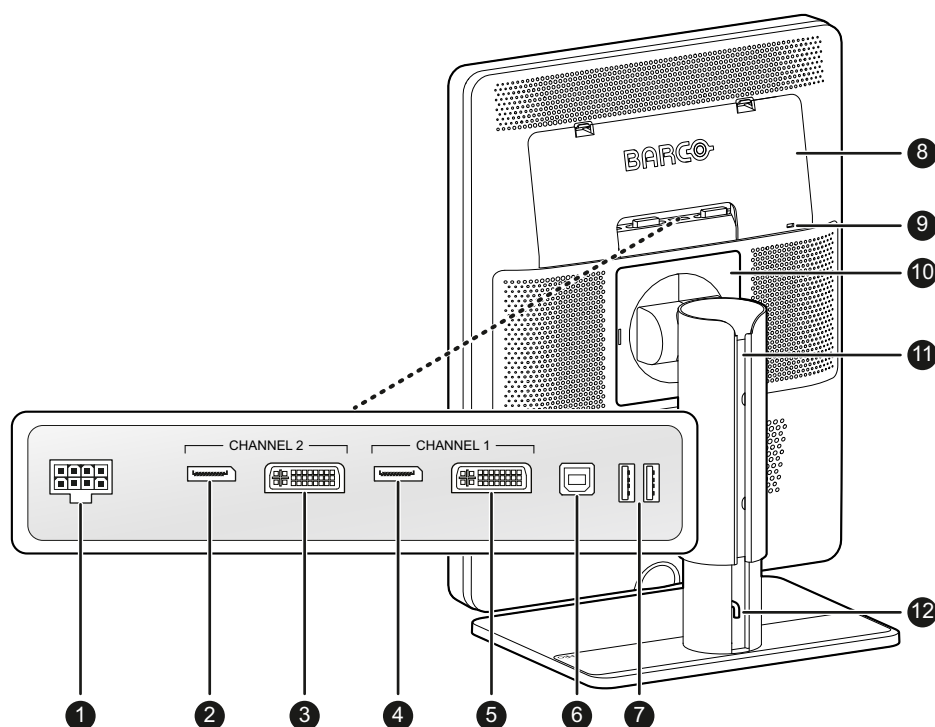

Image 1-2

1. +24 VDC power input
2. Channel 2 DisplayPort video input
3. Channel 2 DVI video input
4. Channel 1 DisplayPort video input
5. Channel 1 DVI video input
6. USB-B 2.0 upstream connector<sup>1</sup>
7. USB-A 2.0 downstream connectors (2x)
8. Connector compartment cover
9. Kensington security lock
10. VESA mount cover plate
11. Cable duct
12. Foot lock clip

<sup>1</sup>. Always connect the display(s) to a USB 3.0 hub, or if unavailable, to a USB 2.0 hub but then no more than two displays can be connected to the same hub.

*1. Welcome!*

---



## 2. INSTALLATION



Prior to installing your Nio Color 5MP and connecting all necessary cables, make sure to have a suitable display controller physically installed in your computer. If you are using a Barco display controller, please consult the user guide delivered with it to do this.

For a list of compatible display controllers, please refer to the latest version of the compatibility matrix available on [my.barco.com](http://my.barco.com) (MyBarco > My Support > Healthcare > Compatibility Matrices > Barco Systems Compatibility Matrices).

### 2.1 Display position adjustment

#### To adjust the display position

1. Pull out the red foot lock clip from the hole at the back of the foot.

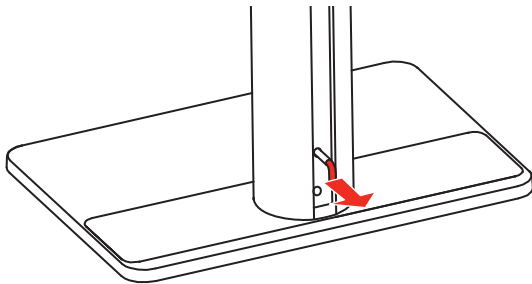

Image 2-1

2. You can now safely tilt, swivel, pivot, raise and lower the display as desired.

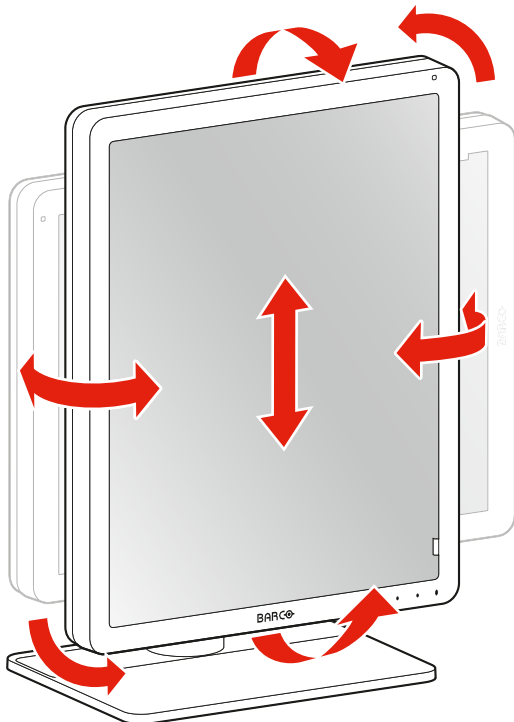

Image 2-2

## 2. Installation

---



**WARNING:** The display must be in its highest position before it can be properly pivoted.

---



Store the foot lock clip in the storage hole in case the display needs to be transported later.

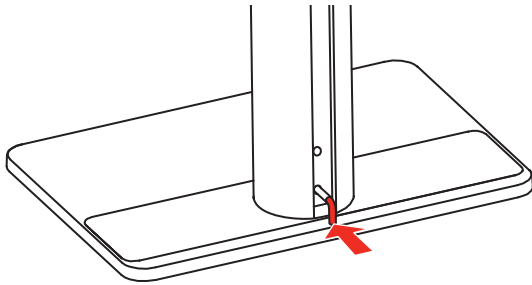

Image 2-3

---



If, after installing the display of the system, you change the panel orientation while an image is on the screen, the result depends on the graphic board and the resolution of the image. In some cases the image will be rotated automatically, in other cases it will not be rotated (e.g., when pixels would be lost after rotation). If necessary, change the image resolution in the display control panel and restart the system after changing the orientation.

---

## 2.2 Cable connections

---

### To connect the cables

1. Open the connector compartment. Do this by gently pushing the two lips on top of the cover, after which it can be removed from the display.

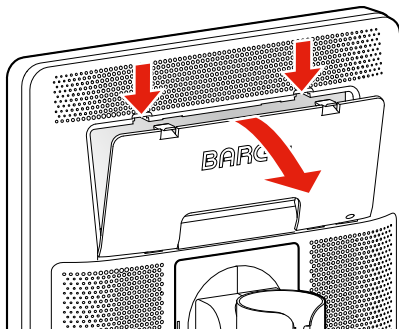

Image 2-4

2. Connect one or more video sources from your workstation(s) to the corresponding video inputs on the display.

**Note:** The MDNC-6121 can have multiple video inputs connected at once, and switching between these inputs can be easily done in the OSD menu. See "Image source selection", page 26 for more info on how to configure the different video inputs on your display.

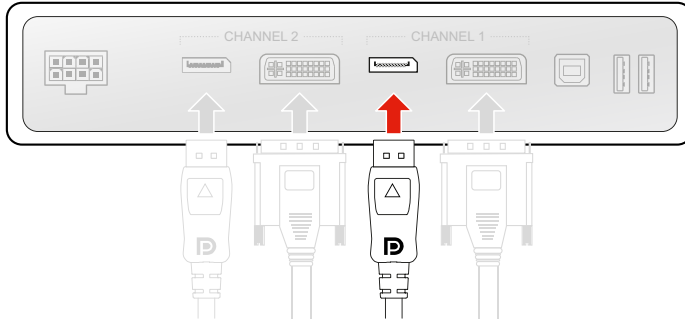

Image 2-5

3. Connect the workstation's USB host to the USB upstream connector on the display if you want to make use of QAWeb or any of the display USB downstream connectors (e.g. to connect a keyboard, mouse, touch pad or other peripheral).

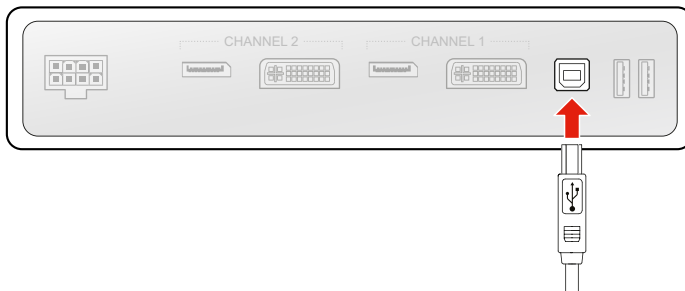

Image 2-6

4. Connect the supplied external DC power supply to the power input on the display.

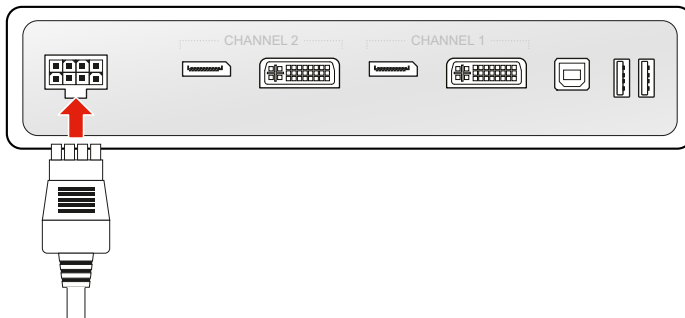

Image 2-7

## 2. Installation

---

5. Route all cables through the cable duct in the stand of your display. For better strain-relief and shielding of the cables, fix the cables with the cable straps at the inside of the connector compartment.

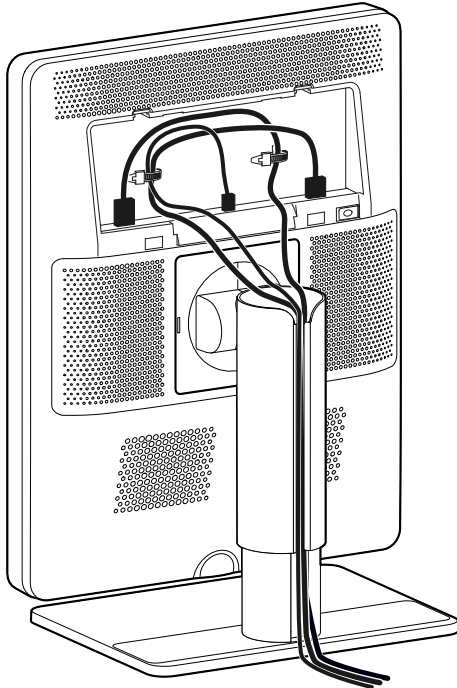

Image 2-8

6. Close the connector compartment cover. You will hear a “click” sound when the cover is in position.

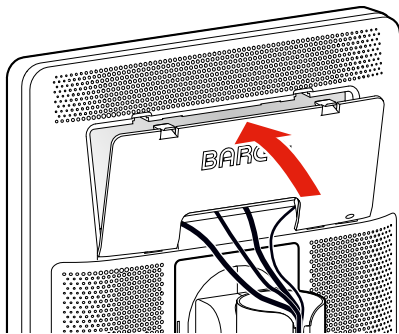

Image 2-9

7. Connect the external DC power supply to a **grounded** power outlet by using one of the power cables included with the display.

## 2.3 VESA-mount installation

---



**CAUTION:** Use suitable mounting apparatus to avoid risk of injury.

---



**WARNING:** Never move a display attached to an arm by pulling or pushing the display itself. Instead, make sure that the arm is equipped with a VESA approved handle and use this to move the display.

Please refer to the instruction manual of the arm for more information and instructions.

---



**WARNING:** Use an arm that is approved by VESA (according to the VESA 100 mm standard).

Use an arm that can support the weight of the display. Refer to the technical specifications of this display for the applicable weight.

### Overview

The panel, standard attached to the tilt & swivel foot, is compatible with the VESA 100 mm standard. So it can be used with an arm stand according to the VESA 100 mm standard.

Therefore, the tilt & swivel foot must be removed from the panel.

1. Put the display in the lowest position and lock the height mechanism.

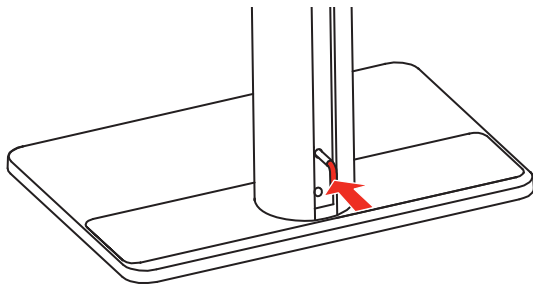

Image 2-10

2. Put the display face down on a clean and soft surface. Be careful not to damage the panel screen.
3. Remove the plastic cover with a flathead screw driver.

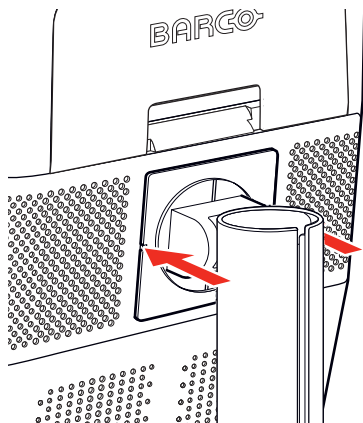

Image 2-11

4. Slide the plastic cover over the neck of the foot.

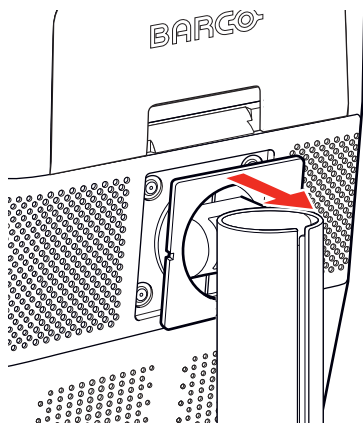

Image 2-12

## 2. Installation

---

5. Remove the four screws fixing the foot while supporting the foot.

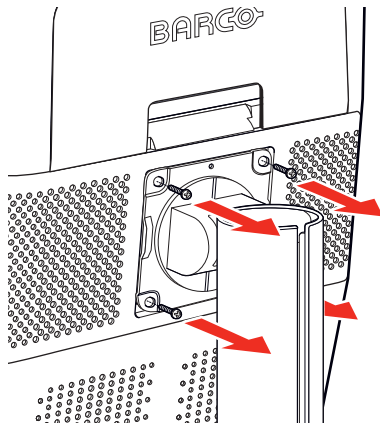

Image 2-13

6. Attach the arm stand **firmly** to the panel using 4 screws M4 x 8 mm.

## 2.4 First time starting up

---

### Overview

You are now ready to start up your Nio Color 5MP for the first time.

1. Switch on your Nio Color 5MP as described in "Standby switching", page 14.
2. Turn on the computer connected to your display.

If you have properly installed your display and display controller, the Windows start-up messages will appear once the boot procedure is finished.



**Your Nio Color 5MP will be running in a basic video mode at a default refresh rate when first time starting up. If you are using a Barco display controller, please consult the user guide delivered with it to install the drivers, software and documentation. When this is done, your display will automatically detect the connected video input signal(s) and apply the correct video mode and refresh rate.**

---

---

## 3. DAILY OPERATION

### 3.1 Recommendations for daily operation

---

#### Optimize the lifetime of your display

Enabling the Display Power Management System (DPMS) of your display will optimize its diagnostic lifetime by automatically switching off the backlight when the display is not used for a specified period of time. By default, DPMS is enabled on your display, but it also needs to be activated on your workstation. To do this, go to “Power Options Properties” in the “Control Panel”.



---

**Barco recommends setting DPMS activation after 20 minutes of non-usage.**

---

#### Use a screen saver to avoid image retention

Prolonged operation of an LCD with the same content on the same screen area may result in a form of image retention.

You can avoid or significantly reduce the occurrence of this phenomenon by using a screen saver. You can activate a screen saver in the “Display properties” window of your workstation.



---

**Barco recommends setting screen saver activation after 5 minutes of non-usage. A good screen saver displays moving content.**

---

In case you are working with the same image or an application with static image elements for several hours continuously (so that the screen saver is not activated), change the image content regularly to avoid image retention of the static elements.

#### Understand pixel technology

LCD displays use technology based on pixels. As a normal tolerance in the manufacturing of the LCD, a limited number of these pixels may remain either dark or permanently lit, without affecting the diagnostic performance of the product. To ensure optimal product quality, Barco applies strict selection criteria for its LCD panels.



---

**To learn more about LCD technology and missing pixels, consult the dedicated white papers available at [www.barco.com/healthcare](http://www.barco.com/healthcare).**

---

#### Enhance user comfort

Every Barco multi-head display system is color matched with the highest specifications in the market.



---

**Barco recommends keeping color-matched displays together. Furthermore, it is important to use all displays of a multi-head configuration at the same rate to preserve color matching throughout the economic lifetime of the system.**

---

#### Maximize quality assurance

The 'MediCal QAWeb' system offers online service for high-grade Quality Assurance, providing maximum diagnostic confidence and uptime.



**Barco recommends to install MediCal QAWeb Agent and apply the default QAWeb policy at least. This policy includes calibration on regular intervals. Connecting to MediCal QAWeb Server offers even more possibilities.**

Learn more and sign up for the free MediCal QAWeb Essential level at [www.barco.com/QAWeb](http://www.barco.com/QAWeb).

---

## 3.2 Key indicator lights

---

#### About the key indicator lights

By default, the indicator lights of the keys will be dimmed which makes the keys unavailable at that moment. To make the keys illuminate and available for further actions touch one of the keys. As a result, all keys will be illuminated and are now available for further actions. However, if no further actions are taken within the following 5 seconds, the keys will dim again.



**The key auto-dim function can be disabled in the OSD menus. Please refer to "Key indicator lights", page 18 for detailed instructions on how to do this.**

---

## 3.3 Standby switching

---

#### About standby switching



**The connected power supply also provides a switch that can be used to turn the power completely off. To use the display, please make sure to switch on this power supply. This can be done by pushing the on/off switch on the power supply into the "I" position.**

---

Switching on the display while it is in standby mode or vice versa can be done by:

1. Illuminate the keys as previously described.
2. While the keys are illuminated, touch the standby key for approximately 2 seconds.

As a result, the display will switch on or will switch to standby mode.



**In case of a power outage recovery, your display will always start-up in the power mode it was in before the power interruption (i.e. standby or on). This protects your display against inadvertent image retention problems.**

---



## 3.4 Bringing up the OSD menus

### How to bring up the OSD menus

The OSD menu allows you to configure different settings to make your Nio Color 5MP fit your needs within your working environment. Also, you can retrieve general information about your display and its current configuration settings through the OSD menu.

Bringing up the OSD menu can be done by:

1. If not already done so, switch on the display as previously described.
2. Illuminate the keys as previously described.
3. While the keys are illuminated, touch the menu key.

As a result, the OSD main menu comes up. However, if no further actions are taken within the following 90 seconds, the OSD will disappear again.



The OSD menu auto-exit function can be disabled in the OSD menu. Please refer to "OSD menu automatic close function", page 17 for detailed instructions on how to do this.

## 3.5 Navigating through the OSD menus

### How to navigate through the OSD menus

Navigating through the OSD menu can be done by:

- Use the left/right keys to move through the (sub)menus, change values or make selections.
- To go into a submenu or confirm adjustments and selections, use the menu key.
- Use the standby key to cancel adjustments or exit a (sub)menu.
- Exit all OSD menus at once by touching the standby key for approximately 2 seconds.



The key icons are displayed above the keys, adapted to the function that it is used for (menu dependent).

#### Overview key icons



Left, Right



Menu



Enter

### 3. Daily operation

---



Cancel



Standby (IEC 60417-5009)

## 4. ADVANCED OPERATION

### 4.1 OSD menu language

#### About the OSD menu language

By default, the OSD menu comes up in English. However, there's a wide range of other languages available for the OSD menu of your Nio Color 5MP.

#### To change the language of the OSD menu:

1. Bring up the OSD main menu.
2. Navigate to the *Configuration > User Interface > Menu* menu.
3. Enter the *Language* submenu.
4. Select one of the available languages and confirm.

### 4.2 OSD menu automatic close function

#### About the OSD menu automatic close function

By default, the OSD menu will disappear automatically after approximately 90 seconds of inactivity. However, this function can be disabled so that the OSD menu remains on the screen until manually closed.

#### To enable/disable the OSD menu automatic close function:

1. Bring up the OSD main menu.
2. Navigate to the *Configuration > User Interface > Menu* menu.
3. Enter the *Automatic Close* submenu.
4. Select *Enabled/Disabled* as desired and confirm.

### 4.3 Power LED

#### About the power LED

To prevent distractions, the power LED is dimmed by default when the display is switched on and used in normal operation. This behavior can be changed so that the power LED will light up during normal operation. Below is an overview of the different power LED states, in ascending order of power consumption:

Display status	Power LED behavior
Off <sup>2</sup>	Dimmed
Hibernate <sup>3</sup> / Soft off <sup>4</sup>	Steady amber
Suspend mode <sup>5</sup>	Slow blinking amber
Standby mode <sup>5</sup>	Fast blinking amber
Normal operation	Dimmed (power LED disabled in OSD, default setting)
	Steady white (power LED enabled in OSD)

2. Power supply unplugged or switched off.  
 3. Requires DPMS mode and Hibernate to be enabled in the OSD menu.  
 4. Switched off via the standby touch key.  
 5. Requires DPMS mode to be enabled in the OSD menu.

### To enable/disable the power LED:

1. Bring up the OSD main menu.
2. Navigate to the *Configuration > User Interface > Indicator Lights* menu.
3. Enter the *Power Status* submenu.
4. Select *Enabled/Disabled* as desired and confirm.

## 4.4 Key indicator lights

---

### About the key indicator lights

By default, after lighting up, the key indicator lights will dim again if no further actions are taken within the following 5 seconds. However, this behavior can be changed so that the key indicator lights are always on or always off.

### To configure the key indicator lights

1. Bring up the OSD main menu.
2. Navigate to the *Configuration > User Interface > Indicator Lights* menu.
3. Enter the *Keys* submenu.
4. Select *Automatic/Always On/Always Off* as desired and confirm.

## 4.5 Power lock function

---

### About the power lock function

By enabling the power lock function, the Nio Color 5MP is forced to remain switched on. This means that it can't be switched to stand-by mode manually until the power lock function is disabled again.

### To enable/disable the power lock function:

1. Bring up the OSD main menu.
2. Navigate to the *Configuration > User Interface > Controls* menu.
3. Enter the *Power Lock* submenu.
4. Select *Enabled/Disabled* as desired and confirm.

## 4.6 DPMS mode

---

### About DPMS mode

Enabling the Display Power Management System (DPMS) mode on your display will optimize its diagnostic lifetime by automatically switching off the backlight when the display is not used for a specified period of time. By default, DPMS mode is enabled on your display, but it also needs to be activated on your workstation. To do this, go to the "Power options properties" window of your workstation.



**Barco recommends setting DPMS activation after 20 minutes of non-usage.**

---



When DPMS mode is enabled on your display, an additional OSD power saving function becomes available: hibernate. Please refer to "Hibernate", page 19 for more information on hibernation and how to enable this function.

---

#### To enable/disable DPMS mode on your display:

1. Bring up the OSD main menu.
2. Navigate to the *Configuration > Power Management* menu.
3. Enter the *DPMS Mode* submenu.
4. Select *Enabled/Disabled* as desired and confirm.

## 4.7 Hibernate

---

### About hibernate

When hibernate is enabled, not only the backlight will be switched off, but also other functionalities will be disabled to further reduce power consumption to a minimum. This happens after a specific period of time which can be manually adjusted.



Hibernate can only be enabled on your display when the DPMS mode is enabled first. Therefore, please refer to "DPMS mode", page 18 to do this.

---



Please connect your keyboard or mouse to your PC rather than to the display's USB ports when hibernate is enabled.

---

#### To enable/disable hibernation on your display:

1. Bring up the OSD main menu.
2. Navigate to the *Configuration > Power Management* menu.
3. Enter the *Hibernate* submenu.
4. Select *Enabled/Disabled* as desired and confirm.

#### To specify the hibernate time-out:

1. Bring up the OSD main menu.
2. Navigate to the *Configuration > Power Management* menu.
3. Enter the *Hibernate Timeout* submenu.
4. Set the time-out value as desired and confirm.

## 4.8 Luminance target

---

### About the luminance target

The luminance target of your Nio Color 5MP is adjustable over a predefined range. When you change the luminance target, the display will adjust its backlight to reach the target.

## 4. Advanced operation

---

### To set the luminance target:

1. Bring up the OSD main menu.
2. Navigate to the *Configuration > Calibration* menu.
3. Enter the *Luminance Target* submenu.
4. Set a luminance target value as desired and confirm.



The default, factory DICOM calibrated luminance value is available in the technical specifications table. The guaranteed backlight lifetime is valid for this setting.

---

## 4.9 Viewing modes

---

### About viewing modes

The Nio Color 5MP can be used in two viewing modes:

- **Diagnostic:** This mode provides the full calibrated luminance and is intended for using the display for diagnostic purposes.
- **Text:** In this mode, the luminance is reduced to approximately half of the luminance. This is intended for using the display with office applications such as word processing. Please note that text mode is not persistent, once powered off, the unit will restart in diagnostic mode.



To quickly switch the viewing mode without having to enter the OSD menu, touch the left and right key at the same time during normal operation.

---



The diagnostic mode should always be selected when the Nio Color 5MP is intended to be used in a diagnostic environment.

---

### To select a viewing mode:

1. Bring up the OSD main menu.
2. Navigate to the *Configuration > Calibration* menu.
3. Enter the *Viewing Mode* submenu.
4. Select *Diagnostic/Text* as desired and confirm.

## 4.10 Display functions

---

### About display functions

Native, uncorrected panels will display all grayscale/color levels with luminance increments that are not optimal for crucial diagnostic information. Studies have shown however, that in medical images certain grayscale/color parts contain more diagnostic information than others. To respond to these conclusions, display functions have been defined. These functions emphasize on these parts containing crucial diagnostic information by correcting the native panel behavior.

The available display functions for your Nio Color 5MP are:

- **Native:** If you select Native, the native panel behavior will not be corrected.
- **Dynamic Gamma 1.8 or 2.2:** These are gamma functions that are shifted to take into account the non-zero luminance of an LCD panel when driven with a “black” signal. They are especially useful in CT applications to improve the perception of low Hounsfield values.
- **DICOM:** DICOM (Digital Imaging and Communications in Medicine) is an international standard that was developed to improve the quality and communication of digital images in radiology. In short, the DICOM display function results in more visible grayscales in the images. Barco recommends selecting the DICOM display function for most medical viewing applications.
- **User:** This display function will be automatically selected when display functions are defined by Medical QAWeb.
- **Gamma 1.8 or 2.2:** Select one of these display functions in case the display is to replace a CRT display with a gamma of 1.8 or 2.2 respectively.



**The settings of the display must be adapted to suit the requirements of the visualization software. In case of doubt, please contact the vendor of the visualization software.**

---

### To select a display function:

1. Bring up the OSD main menu.
2. Navigate to the *Configuration > Calibration* menu.
3. Enter the *Display Function* submenu.
4. Select one of the available display functions and confirm.

## 4.11 Color presets

---

### About color presets

The available color preset settings for your display are:

- **Clearbase:** Simulation of the clearbase film color temperature.
- **Bluebase:** Simulation of the bluebase film color temperature.
- **User:** When selecting the User color temperature setting, you will be able to manually define the X and Y coordinates or the display color temperature in separate submenus.
- **Native White:** The native, unmodified color temperature of the LCD panel.

### To select a color preset:

1. Bring up the OSD main menu.
2. Navigate to the *Configuration > Calibration > Color Settings* menu.
3. Enter the *Color Presets* submenu.
4. Select one of the available Color Presets and confirm.

## 4.12 Ambient Light Compensation (ALC)

---

### About ALC



**Ambient Light Compensation (ALC) can only be enabled on your display when the DICOM display function is selected. Therefore, please refer to "Display functions", page 20 to correctly set the display function.**

---

When ALC is enabled, the DICOM display function will be recalculated taking a preset ambient light correction value into account. This value is determined by the selected reading room. Therefore, it is also important to select a realistic reading room when enabling ALC. This can be done by following the instructions in "Reading rooms", page 22.

#### To enable/disable ALC:

1. Bring up the OSD main menu.
2. Navigate to the *Configuration > Calibration > Ambient Light* menu.
3. Enter the *Ambient Light Compensation* submenu.
4. Select *Enabled/Disabled* as desired and confirm.

## 4.13 Reading rooms

---

### About reading rooms



**Reading rooms can only be selected when the DICOM display function is selected. Therefore, please refer to "Display functions", page 20 to correctly set the display function.**

---

The American Association of Physicists in Medicine (AAPM) composed a list of pre-defined reading rooms. Each of these reading rooms are defined by following parameters:

- the maximum light allowed in this type of room
- the preset ambient light correction value for this reading room

These parameters are stored in your display and determine the preset ambient light correction value to take into account to recalculate the DICOM display function when Ambient Light Compensation (ALC) is enabled. Please refer to "Ambient Light Compensation (ALC)", page 22 to enable ALC.

The available reading rooms for your Nio Color 5MP are:

- **CR/DR/ MAMMO:** Corresponds to light conditions in diagnostic reading rooms for computed radiology, digital radiology or mammography. This setting has the lowest maximum ambient light.
- **CT/MR/NM:** Corresponds to light conditions in diagnostic reading rooms for computed tomography, magnetic resonance or nuclear medicine scans.
- **Staff Office:** Corresponds to light conditions in office rooms.
- **Clinical Viewing Room:** Corresponds to light conditions in diagnostic reading rooms for clinical viewing.
- **Emergency Room:** Corresponds to light conditions in emergency rooms.
- **Operating Room:** Corresponds to light conditions in operating rooms. This setting has the highest maximum ambient light.

#### To select a reading room:

1. Bring up the OSD main menu.



2. Navigate to the *Configuration > Calibration > Ambient Light* menu.
3. Enter the *Reading Room* submenu.
4. Select one of the available reading rooms and confirm.

## 4.14 Continuous ALC

### About Continuous ALC



**Continuous ALC can only be selected when the DICOM display function is selected. Therefore, please refer to "Display functions", page 20 to correctly set the display function.**

Enabling continuous ALC will continuously recalculate the DICOM display function taking the averaged ambient light into account.

#### To select continuous ALC:

1. Bring up the OSD main menu.
2. Navigate to the *Configuration > Calibration > Ambient Light* menu.
3. Enter the *Continuous ALC* submenu.
4. Select *Enabled/Disabled* as desired and confirm.

## 4.15 Embedded QA

### Overview

- About Embedded QA
- DICOM status report
- DICOM compliance check
- DICOM calibration
- Reset DICOM calibration
- DICOM error threshold

#### 4.15.1 About Embedded QA

##### About

Embedded QA allows you to run a display calibration or compliance test directly from the display using the OSD menus described in the next sections. Embedded QA will use the front sensor / I-Guard to measure the necessary luminance levels for either a calibration or compliance test. Various settings for both actions can be selected from the display's OSD menu. The last results of both actions can be consulted from the OSD.

##### Embedded QA or MediCal QAWeb?

Embedded QA is not a replacement for the Barco MediCal QAWeb solution.

Although Embedded QA is a reliable option to perform a simple calibration or compliance test, Barco still highly recommends MediCal QAWeb as the solution of choice for calibration and QA. Medical QAWeb brings many benefits such as centralized asset management, the ability to schedule tasks, remote management, automated reporting, alerting and specific support of regional QA standards such as DIN 6868-57, JESRA and AAPM TG18. That's why MediCal QAWeb Agent acts as the master for all supported dis-

plays from the moment it is installed and running. MediCal QAWeb Agent will take over from Embedded QA and overwrite any settings which were applied by Embedded QA.

### 4.15.2 DICOM status report

#### About DICOM status report

Following information is available:

DICOM Compliance Status (status since last compliance check):

- **Compliance status:** Shows if the current DICOM curve is compliant or not.
- **Maximum error:** Shows the maximum error of the current DICOM curve. This is the deviation compared to a perfect DICOM.
- **Error threshold:** Shows the error threshold. This is the maximum error allowed before a DICOM calibration is required.
- **Time elapsed since latest compliance check:** Shows the backlight runtime since last compliance check.
- **Display Function:** Shows the current display function.
- **Ambient light compensation:** Shows the ambient light compensation status.
- **Reading Room:** Shows the selected reading room.
- **Luminance:** Shows the measured luminance.
- **Black luminance:** Shows the measured black luminance.

DICOM Calibration Status:

- **No calibration executed yet:** No other information is visible
- **Calibration executed:** When the calibration is executed, the following extra information is shown: Backlight runtime elapsed since latest calibration, display function, ambient light compensation, reading room.

Current DICOM Settings

- **Display Function:** Shows the current display function.
- **Ambient Light Compensation:** Shows the ambient light compensation status.
- **Reading room:** Shows the selected reading room.

#### To retrieve the DICOM status report:

1. Bring up the OSD main menu.
2. Navigate to the *Configuration > Calibration > Embedded QA* menu.
3. Select *DICOM status report* to make the information visible on the screen.

### 4.15.3 DICOM compliance check

#### About DICOM compliance check

The DICOM compliance check will measure the DICOM curve of your display in different steps. After measurement, the DICOM status report is shown.

#### To start DICOM compliance check:

1. Bring up the OSD main menu.
2. Navigate to the *Configuration > Calibration > Embedded QA* menu.
3. Select *DICOM compliance check* to start the compliance check.  
**Warning:** Pressing a key during the compliance check will abort the check.

#### 4.15.4 DICOM calibration

##### About DICOM calibration

The DICOM calibration will add a correction to the current DICOM curve to approach the perfect DICOM curve as well as possible.

##### To start DICOM calibration:

1. Bring up the OSD main menu.
2. Navigate to the *Configuration > Calibration > Embedded QA* menu.
3. Select *DICOM calibration* to start the calibration.

**Warning:** *Pressing a key during calibration will abort the calibration, previous values will be restored.*

**Note:** *After calibration, the compliance check will start automatically.*

#### 4.15.5 Reset DICOM calibration

##### About reset DICOM calibration

It is possible to restore the original (not corrected) DICOM curve.

##### To reset the DICOM calibration:

1. Bring up the OSD main menu.
2. Navigate to the *Configuration > Calibration > Embedded QA* menu.
3. Enter the *DICOM preferences* submenu.
4. Select *reset DICOM calibration* to restore the original (not corrected) DICOM curve.

#### 4.15.6 DICOM error threshold

##### About DICOM error threshold

The threshold to define the DICOM compliance can be modified in steps of 5% starting from 5 to 30%. When the maximum deviation is not bigger than the selected threshold, the compliance check will be OK.

##### To set the DICOM error threshold:

1. Bring up the OSD main menu.
2. Navigate to the *Configuration > Calibration > Embedded QA* menu.
3. Enter the *DICOM preferences* submenu.
4. Set *DICOM error threshold* as desired and confirm.

### 4.16 Display orientation

---

#### About Display orientation

Your display automatically detects its physical orientation (portrait or landscape) and, by default, automatically adjusts the image orientation to this. This means that when your display is physically rotated, the image will rotate along.

The OSD menu however, allows to overrule this behavior and force the image orientation to portrait or landscape regardless of the physical orientation of the display. This may be especially useful when operating your display with the screen facing upwards.

#### To set the Display orientation

1. Bring up the OSD main menu.

## 4. Advanced operation

---

2. Navigate to the *Configuration > Image Sources* menu.
3. Enter the *Display Orientation* submenu.
4. Select *Landscape/Portrait/Automatic* as desired and confirm.

### 4.17 Image scaling

---

#### About image scaling

Enabling image scaling will copy each individual pixel to one or more adjacent pixels so that the size of the displayed image will be a multiple of the original image source video input signal.



**Image scaling is only possible when the resolution of your display's video input signal is less than or equal to half the maximum resolution of the display.**

---

#### To enable/disable image scaling:

1. Bring up the OSD main menu.
2. Navigate to the *Configuration > Image Source* menu.
3. Enter the *Scaling* submenu.
4. Select *Enabled/Disabled* as desired and confirm.

### 4.18 Image source selection

---

#### About image source selection

The Nio Color 5MP has 4 video inputs: DisplayPort 1, DVI 1, DisplayPort 2 and DVI 2. The input to be displayed is dependent on the selected **image source selection mode**:

- **Automatic** image source selection mode automatically detects the connected video input and shows it on the screen. If more than one video input is connected, the input to be displayed will be determined based on the following priority mechanism:
  - a) DisplayPort 1 (highest priority)
  - b) DVI 1
  - c) DisplayPort 2
  - d) DVI 2 (lowest priority)
- **Manual** image source selection mode allows to manually select the input to be displayed.
- **Expert** image source selection mode enables the **dual input channel mechanism**. This will make inputs 1 (DisplayPort 1 together with DVI 1) and inputs 2 (DisplayPort 2 together with DVI 2) to be handled as two separate channels. Switching between channel 1 and channel 2 can in its turn be done automatically or manually:
  - Automatic channel selection will automatically detect the connected video input(s) and show it on the screen. Priority will be given to channel 1 inputs if both channels have video input(s) connected. In this way channel 2 can be seen as a backup channel.
  - Manual channel selection allows to manually switch to either channel 1, channel 2 or no channel (causing no input to be displayed).

For each channel, the video input (DisplayPort or DVI) can then also be selected automatically or manually:

- Automatic input selection gives priority to DisplayPort over DVI for each channel.
- Manual input selection allows DisplayPort or DVI to be selected manually per channel.

**To automatically detect the image source:**

1. Bring up the OSD main menu.
2. Navigate to the *Configuration > Image Sources* menu.
3. Enter the *Image Source Selection* submenu and select *Automatic*.

**To manually select an image source:**

1. Bring up the OSD main menu.
2. Navigate to the *Configuration > Image Sources* menu.
3. Enter the *Image Source Selection* submenu and select *One Image Source*.
4. Enter the *Image Source* submenu and select one of the image sources.

**To enable expert mode (dual input channel mechanism):**

1. Bring up the OSD main menu.
2. Navigate to the *Configuration > Image Sources* menu.
3. Enter the *Image Source Selection* submenu and select *Expert*.

**To automatically switch between the input channels:**

1. Bring up the OSD main menu.
2. Navigate to the *Configuration > Image Sources* menu.
3. Enter the *Image Source Selection* submenu and select *Expert*.
4. Enter the *Automatic Selection of Input* submenu and select *Enabled*.

**To manually switch between the input channels:**

1. Bring up the OSD main menu.
2. Navigate to the *Configuration > Image Sources* menu.
3. Enter the *Image Source Selection* submenu and select *Expert*.
4. Enter the *Automatic Selection of Input* submenu and select *Disabled*.
5. Enter the *Left* submenu and select one of the input channels.

**To select the image source on channel 1 and 2:**

1. Bring up the OSD main menu.
2. Navigate to the *Configuration > Image Sources* menu.
3. Enter the *Image Source Selection* submenu and select *Expert*.
4. Enter the *Input 1 or Input 2 Image Source* submenu and select one of the image sources.

---

## 4.19 Grayscale conversion modes

---



Your Nio Color 5MP display automatically detects the connected video input signals and applies the correct grayscale conversion settings. Manually selecting a grayscale conversion mode is possible, but then your display's image source selection mode should be set to allow this. Please refer to "Image source selection", page 26 to do this.

---

### About grayscale conversion modes

Grayscale conversion modes specify how color generated on the display controller is converted to grayscale in your display.

The available grayscale conversion modes are:

No Conversion	
Use Red Channel	This mode is intended for grayscale displays where gray is sent over the red channel.
Use Green Channel	This mode is intended for grayscale displays where gray is sent over the green channel.
Use Blue Channel	This mode is intended for grayscale displays where gray is sent over the blue channel.

### To manually select a grayscale conversion mode:

1. Bring up the OSD main menu.
2. Navigate to the *Configuration > Image Sources > Input Settings > DisplayPort 1/2, DVI 1/2* menu.
3. Enter the *Grayscale Conversion* submenu.
4. Select one of the available color conversion modes and confirm.

## 4.20 EDID format

---

### About EDID format

The Nio Color 5MP supports two EDID formats: E-EDID V1.4 and DisplayID V1.3

### To select the EDID format

1. Bring up the OSD main menu.
2. Navigate to the *Configuration > Image Sources > Input Settings* menu.
3. Enter the *EDID format* submenu.
4. Select one of the available format and confirm.

## 4.21 EDID timings

---

### About EDID timings

Following EDID timings are available for your Nio Color 5MP:

Resolution	Allows to manually modify the resolution of the image source video input signal.
Refresh Rate	Allows to manually select the refresh rate of the image source video input signal depending on the maximum refresh rate of the display controller connected to your display.
Color Depth	Allows to change the color depth to 8 or to 10 bit (only when using DisplayPort input).

### To manually set EDID timings:

1. Bring up the OSD main menu.
2. Navigate to the *Configuration > Image Sources > Input Settings > DisplayPort 1/2, DVI 1/2* menu.

3. Enter the *EDID* submenu.
4. Select one of the available settings and confirm.

## 4.22 Display info

---

### About display info

Your display serial number, color type, native resolution, firmware versions, etc. are available in a dedicated submenu of the OSD menu.

### To retrieve info about your display:

1. Bring up the OSD main menu.
2. Navigate to the *About this Display* menu to make the information visible on the screen.

## 4.23 Display status

---

### About display status

The Status submenu of the OSD menu provides info on the current status of your display (runtimes, temperatures, etc.), the status of the connected image sources (video encoding mode, timings, etc.), the current calibration status of your display (display function, luminance, ALC, etc.) and the status about activated connections.

### To retrieve the status of your display:

1. Bring up the OSD main menu.
2. Navigate to the *Status* menu.
3. Enter the *Display*, *Image Sources*, *Calibration* or *Connectivity* submenu as desired.

#### 4. *Advanced operation*

---



# 5. CLEANING YOUR DISPLAY

## 5.1 Cleaning instructions

---

### To clean the display

Clean the display using a sponge, cleaning cloth or soft tissue, lightly moistened with a recognized cleaning product for medical equipment. Read and follow all label instructions on the cleaning product. In case of doubt about a certain cleaning product, use plain water.

Do not use following products:

- Alcohol/solvents at higher concentration > 5%
- Strong alkalis lye, strong solvents
- Acid
- Detergents with fluoride
- Detergents with ammonia
- Detergents with abrasives
- Steel wool
- Sponge with abrasives
- Steel blades
- Cloth with steel thread



**CAUTION:** Take care not to damage or scratch the front glass or LCD. Be careful with rings or other jewelry and do not apply excessive pressure on the front glass or LCD.

---



**CAUTION:** Do not apply or spray liquid directly to the display as excess liquid may cause damage to internal electronics. Instead, apply the liquid to a cleaning cloth.

---



# 6. IMPORTANT INFORMATION

## 6.1 Safety information

---

### General recommendations

Read the safety and operating instructions before operating the device.

Retain safety and operating instructions for future reference.

Adhere to all warnings on the device and in the operating instructions manual.

Follow all instructions for operation and use.

### Electrical Shock or Fire Hazard

To prevent electric shock or fire hazard, do not remove cover.

No serviceable parts inside. Refer servicing to qualified personnel.

Do not expose this apparatus to rain or moisture.

### Modifications to the unit

Do not modify this equipment without authorization of the manufacturer.

### Type of protection (electrical):

Display with external power supply: Class I equipment.

### Degree of safety (flammable anesthetic mixture)

Equipment not suitable for use in the presence of a flammable anesthetic mixture with air or with oxygen or nitrous oxide.

### Non-patient care equipment

- Equipment primarily for use in a health care facility that is intended for use where contact with a patient is unlikely (no applied part).
- The equipment shall not be used with life support equipment.
- The user should not touch the equipment, nor its signal input ports (SIP)/signal output ports (SOP) and the patient at the same time.

### Power connection – Equipment with external 24 VDC power supply

- Power requirements: The equipment must be powered using the delivered medical approved 24 VDC (≡) SELV power supply.
- The medical approved DC (≡) power supply must be powered by the AC mains voltage.
- The power supply is specified as a part of the ME equipment or combination is specified as a ME system.
- To avoid the risk of electric shock, this equipment must only be connected to a supply mains with protective earth.
- The equipment should be installed near an easily accessible outlet.
- The equipment is intended for continuous operation.

### Transient over-voltage

If the device is not used for a long time, disconnect it from the AC inlet to avoid damage by transient over-voltage.

## 6. Important information

---

To fully disengage the power to the device, please disconnect the power cord from the AC inlet.

### High magnetic environment

- The device shall not be used in the high magnetic environment of an MRI scanner.
- The installer shall assess the magnetic environment before installation or use of the device.

### Power cords:

- Do not overload wall outlets and extension cords as this may result in fire or electric shock.
- Mains lead protection (U.S.: Power cord): Power cords should be routed so that they are not likely to be walked upon or pinched by items placed upon or against them, paying particular attention to cords at plugs and receptacles.
- Use a power cord that matches the voltage of the power outlet, which has been approved and complies with the safety standard of your particular country.

### Water and moisture

Never expose the display to rain or moisture.

Never use the display near water - e.g. near a bathtub, washbasin, swimming pool, kitchen sink, laundry tub or in a wet basement.

### Ventilation

Do not cover or block any ventilation openings in the cover of the set. When installing the device in a cupboard or another enclosed location, heed the necessary space between the set and the sides of the cupboard.

### Installation

Place the device on a flat, solid and stable surface that can support the weight of at least 3 devices. If you use an unstable cart or stand, the device may fall, causing serious injury to a child or adult, and serious damage to the device.

### Malfunctions

Disconnect the equipment's power cord from the AC inlet and refer servicing to qualified service technicians under the following conditions:

- If the power cord or plug is damaged or frayed.
- If liquid has been spilled into the equipment.
- If the equipment has been exposed to rain or water.
- If the equipment does not operate normally when the operating instructions are followed. Adjust only those controls that are covered by the operating instructions since improper adjustment of other controls may result in damage and will often require extensive work by a qualified technician to restore the product to normal operation.
- If the equipment has been dropped or the cabinet has been damaged.
- If the product exhibits a distinct change in performance, indicating a need for service.

### This apparatus conforms to:

CE0120 (MDD 93/42/EEC; A1:2007/47/EC class IIb product), CE - 2014/30/EU, CE - 93/42/EEC; A1:2007/47/EC class II b, IEC 60950-1:2005 + A1:2009 (2ND EDITION), IEC 60601-1:2005 + C1:2006 + C2:2007 + A1:2012, ANSI/AAMI ES 60601-1:2005 + C1:2009 + R1:2012, CAN/CSA-C22.2 No. 60601-1:2014, DEMKO - EN 60601-1:2006 + A11:2011 + A12:2014 + A1: 2013, EN 60601-1-2:2007, CCC - GB9254-2008 + GB4943.1-2011 + GB17625.1-2003, KC, VCCI, FCC class B, ICES-001 Level B, FDA 510(k), RoHS

### National Scandinavian Deviations for CL. 1.7.2

Finland: "Laitte on liitettävä suojamaadoituskoskettimilla varustettuun pistorasiaan"

Norway: "Apparatet må tilkoples jordet stikkontakt"

Sweden: "Apparaten skall anslutas till jordat uttag"

## 6.2 Environmental information

### Disposal Information

Waste Electrical and Electronic Equipment



■ This symbol on the product indicates that, under the European Directive 2012/19/EU governing waste from electrical and electronic equipment, this product must not be disposed of with other municipal waste. Please dispose of your waste equipment by handing it over to a designated collection point for the recycling of waste electrical and electronic equipment. To prevent possible harm to the environment or human health from uncontrolled waste disposal, please separate these items from other types of waste and recycle them responsibly to promote the sustainable reuse of material resources.

For more information about recycling of this product, please contact your local city office or your municipal waste disposal service.

For details, please visit the Barco website at: <http://www.barco.com/en/AboutBarco/weee>

### Turkey RoHS compliance



■ Türkiye Cumhuriyeti: AEEE Yönetmeliğine Uygundur.

[Republic of Turkey: In conformity with the WEEE Regulation]

### 中国大陆 RoHS

Chinese Mainland RoHS

根据中国大陆《电器电子产品有害物质限制使用管理办法》(也称为中国大陆RoHS), 以下部分列出了Barco产品中可能包含的有毒和/或有害物质的名称和含量。中国大陆RoHS指令包含在中国信息产业部MCV标准:“电子信息产品中有毒物质的限量要求”中。

According to the “Management Methods for the Restriction of the Use of Hazardous Substances in Electrical and Electronic Products” (Also called RoHS of Chinese Mainland), the table below lists the names and contents of toxic and/or hazardous substances that Barco’s product may contain. The RoHS of Chinese Mainland is included in the MCV standard of the Ministry of Information Industry of China, in the section “Limit Requirements of toxic substances in Electronic Information Products”.

零件项目(名称) Component name	有毒有害物质或元素 Hazardous substances and elements					
	铅 Pb	汞 Hg	镉 Cd	六价铬 Cr6+	多溴联苯 PBB	多溴二苯醚 PBDE
印制电路配件 Printed Circuit Assemblies	x	o	o	o	o	o
液晶面板 LCD panel	x	o	o	o	o	o
外接电(线)缆 External Cables	x	o	o	o	o	o

## 6. Important information

零件项目(名称) Component name	有毒有害物质或元素 Hazardous substances and elements					
	铅 Pb	汞 Hg	镉 Cd	六价铬 Cr6+	多溴联苯 PBB	多溴二苯醚 PBDE
内部线路 Internal wiring	0	0	0	0	0	0
金属外壳 Metal enclosure	0	0	0	0	0	0
塑胶外壳 Plastic enclosure	0	0	0	0	0	0
散热片(器) Heatsinks	0	0	0	0	0	0
电源供应器 Power Supply Unit	x	0	0	0	0	0
风扇 Fan	0	0	0	0	0	0
文件说明书 Paper Manuals	0	0	0	0	0	0
光盘说明书 CD manual	0	0	0	0	0	0

本表格依据SJ/T 11364的规定编制

This table is prepared in accordance with the provisions of SJ/T 11364.

0: 表示该有毒有害物质在该部件所有均质材料中的含量均在 GB/T 26572 标准规定的限量要求以下。

0: Indicates that this toxic or hazardous substance contained in all of the homogeneous materials for this part is below the limit requirement in GB/T 26572.

x: 表示该有毒有害物质至少在该部件的某一均质材料中的含量超出 GB/T 26572 标准规定的限量要求。

x: Indicates that this toxic or hazardous substance contained in at least one of the homogeneous materials used for this part is above the limit requirement in GB/T 26572.

在中国大陆销售的相应电子信息产品(EIP)都必须遵照中国大陆《电子电气产品有害物质限制使用标识要求》标准贴上环保使用期限(EFUP)标签。Barco产品所采用的EFUP标签(请参阅实例, 徽标内部的编号用于指定产品)基于中国大陆的《电子信息产品环保使用期限通则》标准。

All Electronic Information Products (EIP) that are sold within Chinese Mainland must comply with the "Marking for the restriction of the use of hazardous substances in electrical and electronic product" of Chinese Mainland, marked with the Environmental Friendly Use Period (EFUP) logo. The number inside the EFUP logo that Barco uses (please refer to the photo) is based on the "General guidelines of environment-friendly use period of electronic information products" of Chinese Mainland.



## 6.3 Regulatory compliance information

---

### Indications for use

The MDNC-6121 is intended to be used in displaying and viewing digital images, including standard and multi-frame digital mammography, for review, analysis and diagnosis by trained medical practitioners. It is specially designed for breast tomosynthesis applications.

### Manufacturing country

The manufacturing country of the product is indicated on the product label (“**Made in ...**”).

### Importers contact information

To find your local importer, contact one of Barco’s regional offices via the contact information provided on our website ([www.barco.com](http://www.barco.com)).

### FCC class B

This device complies with Part 15 of the FCC Rules. Operation is subject to the following two conditions: (1) this device may not cause harmful interference, and (2) this device must accept any interference received, including interference that may cause undesired operation.

This device has been tested and found to comply with the limits for a Class B digital device, pursuant to Part 15 of the FCC Rules. These limits are designed to provide reasonable protection against harmful interference in a residential installation. This device generates, uses and can radiate radio frequency energy and, if not installed and used in accordance with the instructions, may cause harmful interference to radio communications. However, there is no guarantee that interference will not occur in a particular installation. If this device does cause harmful interference to radio or television reception, which can be determined by turning the device off and on, the user is encouraged to try to correct the interference by one or more of the following measures:

- Reorient or relocate the receiving antenna.
- Increase the separation between the device and receiver.
- Connect the device into an outlet on a circuit different from that to which the receiver is connected.
- Consult the dealer or an experienced radio/TV technician for help.

Changes or modifications not expressly approved by the party responsible for compliance could void the user’s authority to operate the equipment.

### Canadian notice

CAN ICES-1/NMB-1

## 6.4 EMC notice

---

### General information

No specific requirement on the use of external cables or other accessories except power supply.

With the installation of the device, use only the delivered power supply or a spare part provided by the legal manufacturer. Using another can result in a decrease of the immunity level of the device.

### Electromagnetic emissions

The Nio Color 5MP is intended for use in the electromagnetic environment specified below. The customer or the user of the Nio Color 5MP should assure that it is used in such an environment.

## 6. Important information

Emissions test	Compliance	Electromagnetic environment – Guidance
RF emissions CISPR 11	Group 1	The Nio Color 5MP uses RF energy only for its internal function. Therefore, its RF emissions are very low and are not likely to cause any interference in nearby electronic equipment.
RF emissions CISPR 11	Class B	The Nio Color 5MP is suitable for use in all establishments, including domestic establishments and those directly connected to the public low-voltage power supply network that supplies buildings used for domestic purposes.
Harmonic emissions IEC 61000-3-2	Class D	
Voltage fluctuations/ flicker emissions IEC 61000-3-3	Complies	

This Nio Color 5MP complies with appropriate medical EMC standards on emissions to, and interference from surrounding equipment. Operation is subject to the following two conditions: (1) this device may not cause harmful interference, and (2) this device must accept any interference received, including interference that may cause undesired operation.

Interference can be determined by turning the equipment off and on.

If this equipment does cause harmful interference to, or suffer from harmful interference of, surrounding equipment, the user is encouraged to try to correct the interference by one or more of the following measures:

- Reorient or relocate the receiving antenna or equipment.
- Increase the separation between the equipment and receiver.
- Connect the equipment into an outlet on a circuit different from that to which the receiver is connected.
- Consult the dealer or an experienced technician for help.

### Electromagnetic immunity

The Nio Color 5MP is intended for use in the electromagnetic environment specified below. The customer or the user of the Nio Color 5MP should assure that it is used in such an environment.

Immunity test	IEC 60601 Test levels	Compliance level	Electromagnetic environment – guidance
Electrostatic discharge (ESD) IEC 61000-4-2	± 6kV contact ± 8kV air	± 6kV contact ± 8kV air	Floors should be wood, concrete or ceramic tile. If floors are covered with synthetic material, the relative humidity should be at least 30%
Electrical fast transient/burst IEC 61000-4-4	± 2kV for power supply lines ± 1kV for input/ output lines	± 2kV for power supply lines ± 1kV for input/ output lines	Mains power quality should be that of a typical commercial or hospital environment
Surge IEC61000-4-5	± 1 kV line(s) to line(s) ± 2 kV line(s) to earth	± 1 kV line(s) to line(s) ± 2 kV line(s) to earth	Mains power quality should be that of a typical commercial or hospital environment



Immunity test	IEC 60601 Test levels	Compliance level	Electromagnetic environment – guidance
Voltage dips, short interruptions and voltage variations on power supply input lines IEC 61000-4-11	< 5% $U_T$ <sup>6</sup> (> 95% dip in $U_T$ ) for 0.5 cycle 40% $U_T$ (60% dip in $U_T$ ) for 5 cycles 70% $U_T$ (30% dip in $U_T$ ) for 25 cycles < 5% $U_T$ (>95% dip in $U_T$ ) for 5s	< 5% $U_T$ (> 95% dip in $U_T$ ) for 0.5 cycle 40% $U_T$ (60% dip in $U_T$ ) for 5 cycles 70% $U_T$ (30% dip in $U_T$ ) for 25 cycles < 5% $U_T$ (>95% dip in $U_T$ ) for 5s	Mains power quality should be that of a typical commercial or hospital environment. If the user of the Nio Color 5MP requires continued operation during power mains interruptions, it is recommended that the Nio Color 5MP be powered from an uninterruptible power supply or a battery.
Power frequency (47-63 Hz) magnetic field IEC 61000-4-8	3 A/m	Not applicable <sup>7</sup>	Power frequency magnetic fields should be at levels characteristic of a typical location in a typical commercial or hospital environment.
Conducted RF IEC 61000-4-6 Radiated RF IEC 61000-4-3	3 Vrms 150 kHz to 80 MHz 3 V/m 80 MHz to 2.5 GHz	3 V 3 V/m	Portable and mobile RF communications equipment should be used no closer to any part of the Nio Color 5MP, including cables, than the recommended separation distance calculated from the equation applicable to the frequency of the transmitter. Recommended separation distance <b><math>d = 1.2\sqrt{P}</math></b> <b><math>d = 1.2\sqrt{P}</math></b> 80 MHz to 800 MHz <b><math>d = 2.3\sqrt{P}</math></b> 800 MHz to 2.5 GHz Where P is the maximum output power rating of the transmitter in watts (W) according to the transmitter manufacturer and d is the recommended separation distance in meters (m). Field strengths from fixed RF transmitters, as determined by an electromagnetic site survey, <sup>8</sup> should be less

<sup>6</sup>. is the a.c. mains voltage prior to application of the test level.

<sup>7</sup>. Nio Color 5MP doesn't contain susceptible components to magnetic fields

## 6. Important information

Immunity test	IEC 60601 Test levels	Compliance level	Electromagnetic environment – guidance
			than the compliance level in each frequency range. <sup>9</sup> Interference may occur in the vicinity of equipment marked with symbol: 



At 80 MHz and 800 MHz, the higher frequency range applies.



These guidelines may not apply in all situations. Electromagnetic propagation is affected by absorption and reflection from structures, objects and people.

### Recommended separation distance

The Nio Color 5MP is intended for use in an electromagnetic environment in which radiated RF disturbances are controlled. The customer or the user of the Nio Color 5MP can help prevent electromagnetic interference by maintaining a minimum distance between portable and mobile RF communications equipment (transmitters) and the Nio Color 5MP as recommended below, according to the maximum output power of the communications equipment.

Rated maximum output power of transmitter <sup>10</sup> W	Separation distance according to frequency of transmitter		
	150kHz to 80MHz $d=1.2\sqrt{P}$	80MHz to 800MHz $d=1.2\sqrt{P}$	800MHz to 2.5GHz $d=2.3\sqrt{P}$
0.01	0.12	0.12	0.23
0.1	0.38	0.38	0.73
1	1.2	1.2	2.3
10	3.8	3.8	7.3
100	12	12	23



At 80 MHz and 800 MHz, the separation distance for the higher frequency range applies.

8. Field strengths from fixed transmitters, such as base stations for radio (cellular/cordless) telephones and land mobile radios, amateur radio, AM and FM radio broadcast and TV broadcast cannot be predicted theoretically with accuracy. To assess the electromagnetic environment due to fixed RF transmitters, an electromagnetic site survey should be considered. If the measured field strength in the location in which the Nio Color 5MP is used exceeds the applicable RF compliance level above, the Nio Color 5MP should be observed to verify normal operation. If abnormal performance is observed, additional measures may be necessary, such as re-orienting or relocating the Nio Color 5MP.

9. Over the frequency range 150 kHz to 80 MHz, field strengths should be less than 3 V/m.

10. For transmitters rated at a maximum output power not listed above, the recommended separation distance  $d$  in meters (m) can be estimated using the equation applicable to the frequency of the transmitter. Where  $P$  is the maximum output power rating of the transmitter in watts (W) according to the transmitter manufacturer.













These guidelines may not apply in all situations. Electromagnetic propagation is affected by absorption and reflection from structures, objects and people.







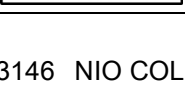





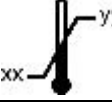

## 6.5 Explanation of symbols

### Symbols on the device

On the device or power supply, you may find the following symbols (nonrestrictive list):

	Indicates compliance with Part 15 of the FCC rules (Class A or Class B)
	Indicates the device is approved according to the UL regulations
	Indicates the device is approved according to the UL regulations for Canada and US
	Indicates the device is approved according to the UL regulations for Canada and US
	Indicates the device is approved according to the UL Demko regulations
	Indicates the device is approved according to the CCC regulations
	Indicates the device is approved according to the VCCI regulations
	Indicates the device is approved according to the KC regulations
	Indicates the device is approved according to the BSMI regulations
	Indicates the device is approved according to the PSE regulations
	Indicates the device is approved according to the EAC regulations
	Caution: Federal law (United States of America) restricts this device to sale by or on the order of a licensed healthcare practitioner.

## 6. Important information





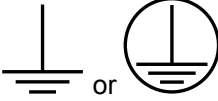

	Indicates the USB connectors on the device
	Indicates the DisplayPort connectors on the device
	Indicates the legal manufacturer
	Indicates the manufacturing date
	Indicates the temperature limitations <sup>11</sup> for the device to safely operate within specs
	Indicates the device serial number
	Indicates the device part number or catalogue number
	<b>Warning:</b> dangerous voltage
	<b>Caution</b>
	Consult the operating instructions
	Indicates this device must not be thrown in the trash but must be recycled, according to the European WEEE (Waste Electrical and Electronic Equipment) directive
	Indicates Direct Current (DC)
	Indicates Alternating Current (AC)
	Stand-by

<sup>11</sup>. Values for xx and yy can be found in the technical specifications paragraph.

	Equipotentiality
	Protective earth (ground)

### Symbols on the box

On the box of the device, you may find the following symbols (nonrestrictive list):

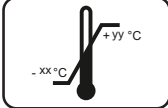
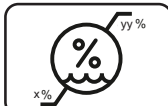
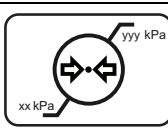
	Indicates a medical device that can be broken or damaged if not handled carefully when being stored.
	Indicates a medical device that needs to be protected from moisture when being stored.
	Indicates the storage direction of the box. The box must be transported, handled and stored in such a way that the arrows always point upwards.
	Indicates the maximum number of boxes to be stacked on each other.
	Indicates that the box should be carried with two persons.
	Indicates that the box should not be cut with a knife, a cutter or any other sharp object.
	Indicates the temperature limits to which the medical device can be safely exposed when being stored.
	Indicates the range of humidity to which the medical device can be safely exposed when being stored.
	Indicates the range of atmospheric pressure to which the medical device can be safely exposed when being stored.

## 6.6 Legal disclaimer

### Disclaimer notice

Although every attempt has been made to achieve technical accuracy in this document, we assume no responsibility for errors that may be found. Our goal is to provide you with the most accurate and usable documentation possible; if you discover errors, please let us know.

Barco software products are the property of Barco. They are distributed under copyright by Barco NV or Barco Inc., for use only under the specific terms of a software license agreement between Barco NV or Barco Inc. and the licensee. No other use, duplication, or disclosure of a Barco software product, in any form, is authorized.

## 6. Important information

---

The specifications of Barco products are subject to change without notice.

### Trademarks

All trademarks and registered trademarks are property of their respective owners.

### Copyright notice

This document is copyrighted. All rights are reserved. Neither this document, nor any part of it, may be reproduced or copied in any form or by any means - graphical, electronic, or mechanical including photocopying, taping or information storage and retrieval systems - without written permission of Barco.

© 2018 Barco NV all rights reserved.

### Patent protection

Please refer to [www.barco.com/about-barco/legal/patents](http://www.barco.com/about-barco/legal/patents)

## 6.7 Technical specifications

---

### Overview

<b>Screen technology</b>	LCD
<b>Active screen size (diagonal)</b>	541 mm (21.3")
<b>Active screen size (H x V)</b>	324.45 x 432.6 mm (12.77" x 17")
<b>Aspect ratio (H:V)</b>	3:4 for each display in portrait mode, 3:2 overall
<b>Resolution</b>	5.8 MP (2100 x 2800 pixels)
<b>Pixel pitch</b>	0.1545 mm
<b>Color imaging</b>	Yes
<b>Gray imaging</b>	Yes
<b>Bit depth</b>	30 bit
<b>Viewing angle (H, V)</b>	178°
<b>Uniformity correction</b>	ULT
<b>SteadyColor</b>	Yes, when used as system with MXRT display controller
<b>SteadyGray</b>	Yes
<b>Ambient Light Compensation (ALC)</b>	Yes
<b>Front sensor</b>	Yes
<b>Maximum luminance</b>	1000 cd/m <sup>2</sup>
<b>DICOM calibrated luminance</b>	500 cd/m <sup>2</sup>
<b>Contrast ratio (panel typical)</b>	1400:1
<b>Response time ((Tr + Tf)/2) (typical)</b>	12.5 ms
<b>Housing color</b>	RAL 9003 / RAL 9004
<b>Video input signals</b>	DVI-D Dual Link (2x) DisplayPort (2x)

<b>USB ports</b>	1x USB 2.0 upstream (endpoint) 2x USB 2.0 downstream
<b>Power rating</b>	24 VDC, 5 A; 5 VDC, 0.1 A
<b>Power requirements</b>	This device shall only be powered by the following medical approved power supplies: Adapter Technology, type CMD160-P240 Ratings marked on the medical power supply: <ul style="list-style-type: none"> <li>• Input rating: 100–240 VAC, 1.9–0.8 A, 50/60 HZ</li> <li>• Output rating: 24 VDC, 6.3 A; 5 VDC, 0.5 A</li> </ul> Efore (Roal Electronics), type RHPS390A Ratings marked on the medical power supply: <ul style="list-style-type: none"> <li>• Input rating: 100–240 VAC, 3.0 A, 50/60 HZ</li> <li>• Output rating: 24 VDC, 8.33 A; 5 VDC, 0.1 A</li> </ul>
<b>Power consumption</b>	60 W (nominal) < 0.5 W (standby)
<b>Dimensions with stand (W x H x D)</b>	Portrait: 378 x 528~628 x 235 mm Landscape: 491 x 472~572 x 235 mm
<b>Dimensions w/o stand (W x H x D)</b>	Portrait: 378 x 491 x 84 mm Landscape: 491 x 378 x 84 mm
<b>Dimensions packaged (W x H x D)</b>	500 x 280 x 670 mm
<b>Net weight with stand</b>	11.6 kg
<b>Net weight w/o stand</b>	6.6 kg
<b>Net weight packaged</b>	17.0 kg (without optional accessories)
<b>Tilt</b>	-10° to +30°
<b>Swivel</b>	-45° to +45°
<b>Pivot</b>	90°
<b>Height adjustment range</b>	100 mm
<b>Mounting standard</b>	VESA (100 mm)
<b>Screen protection</b>	Protective, anti-reflective glass cover
<b>Recommended modalities</b>	All digital images, including digital mammography
<b>Certifications</b>	CE0120 (MDD 93/42/EEC; A1:2007/47/EC class IIb product), CE 2014/30/EU, CE93/42/EEC; A1:2007/47/EC class II b, IEC 60601-1:2005 + C1:2006 + C2:2007 + A1:2012, ANSI/AAMI ES60601-1:2005 + C1:2009 + R1:2012, CAN/CSAC22.2No. 60601-1:2014, DEMKO EN60601-1:2006 + A11:2011 + A12:2014 + A1: 2013, EN 60601-1-2:2007, FCC class B, ICES-001 Level B, FDA 510(k), RoHS

## 6. Important information

---

<b>Supplied accessories</b>	User guide Documentation disc System disc Video cable (1 x DisplayPort) Mains cables (UK, European (CEBEC/KEMA), USA (UL/CSA; adaptor plug NEMA515P), Chinese (CCC)) USB 2.0 cable External power supply
<b>Optional accessories</b>	Graphics board
<b>QA software</b>	MediCal QAWeb
<b>Warranty</b>	5 years, including 40000 hrs backlight warranty
<b>Operating temperature</b>	0 °C to 40 °C (15 °C to 35 °C within specs)
<b>Storage temperature</b>	-20 °C to 60 °C
<b>Operating humidity</b>	8% to 80% (non-condensing)
<b>Storage humidity</b>	5% to 85% (non-condensing)
<b>Operating pressure</b>	70 kPa minimum
<b>Storage pressure</b>	50 to 106 kPa